



# Prefi<sup>®</sup>



PREFI PRE-ENGINEERED CAMP SITE BUILDINGS CO.



**500 MAN CAMP PROJECT**

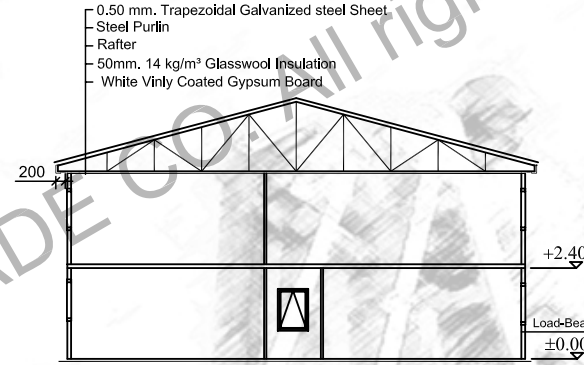
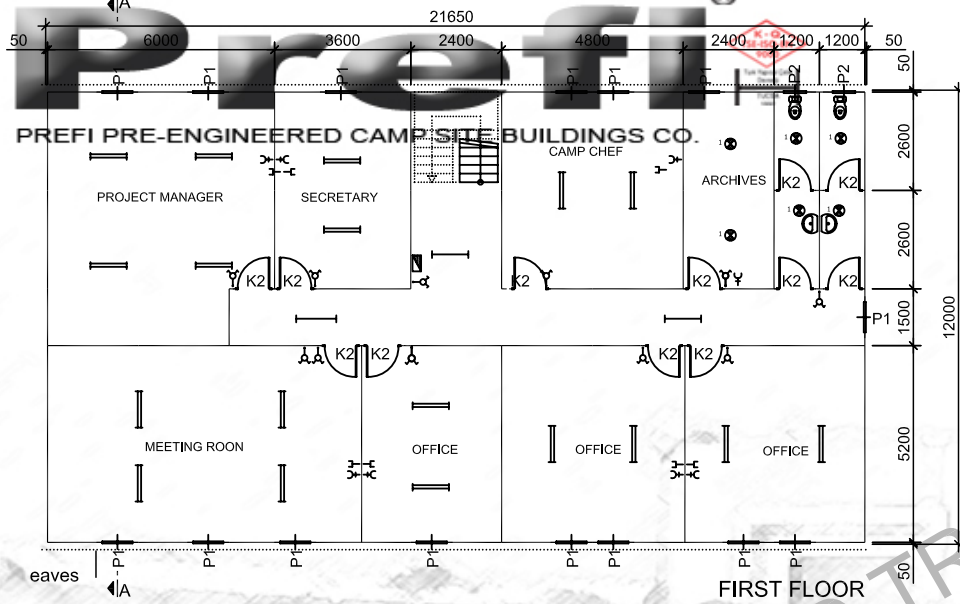

P1	WINDOW	800x1100
P2	WINDOW	600x400
K1	EX. DOOR	850x2000
K2	IN. DOOR	840x2000
K3	EX. DOOR	1760x2000
K4	IN. DOOR	740x2000
⊕	SWITCH	
⊕	DOUBLE SWITCH	
—	1 X 40 TMS ARMATURE	
—	2 X 40 TMS ARMATURE	
⊕	LATERAL EARTH SOCKET	
⊕	TELEPHONE	
⊕	C TYPE GLOBE	
⊕	C TYPE GLOBE WITH WIRE GUARD	
⊕	(220V) SURFACE MOUNTING FUSE BOX	
ALL MEASURED IN MILLIMETERS		

External Surfaces 0.70 mm Thickness  
Coil-coated Painted  
PVC Film Coated Galvanize Steel.  
50 mm 14 kg/m<sup>2</sup> Thickness Glasswool  
Box Profile And/Or Specially Formed Profiles  
Internal Wall Clad 8 mm Thickness Cement  
Bounded Particular Panel

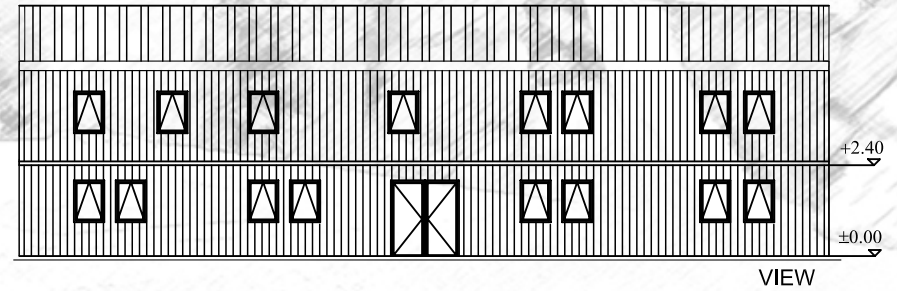
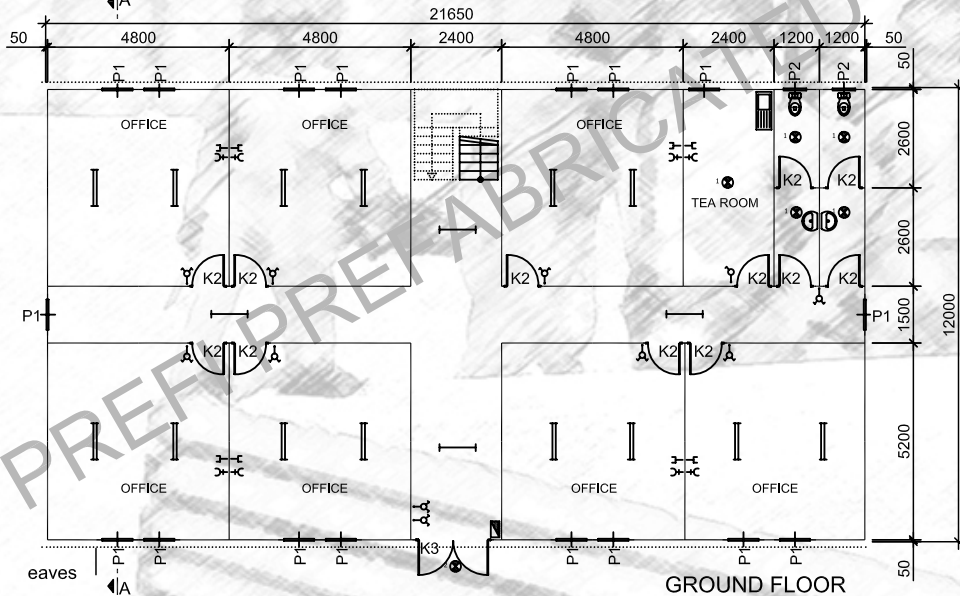

**P r e f i**

PREFABRİK YAPI END. BİLİŞİM ve TİCARET LTD.ŞTİ.  
Ankara - İstanbul Karayolu, 30. km  
Akıncı Kavşağı, Kazan 06980 Ankara  
Tel:90(312) 814 40 92(Pbx) Fax:90(312) 814 40 97  
www.Prefi.com.tr e-posta: prefiprefi.com

ÇİZEN:  
DRAWN:  
KONTROL:  
CHK:  
ONAYLAMA:  
APPROVAL: **H. VAKUR YILMAZYİĞİT**

FİRMA /COMPANY:  
**500 PERSON CAMP**  
TARİH/DATE:

BAŞLIK /TITLE:  
**ADMINISTRATIVE OFFICE BUILDING**  
**GLV-BET**  
REFERANS:  
REV.NO:  
SAYFA /PAGE:

2  
m  
519.6  
1/16

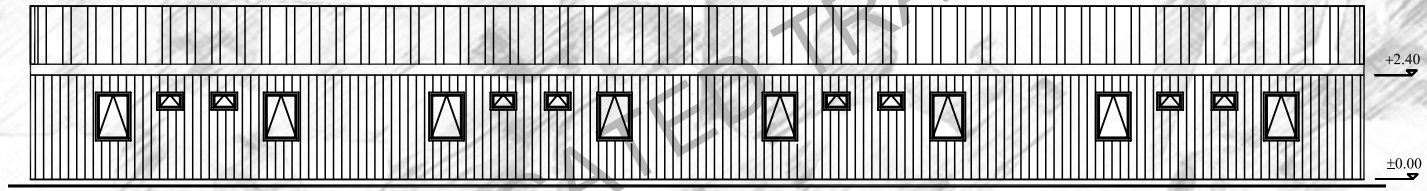
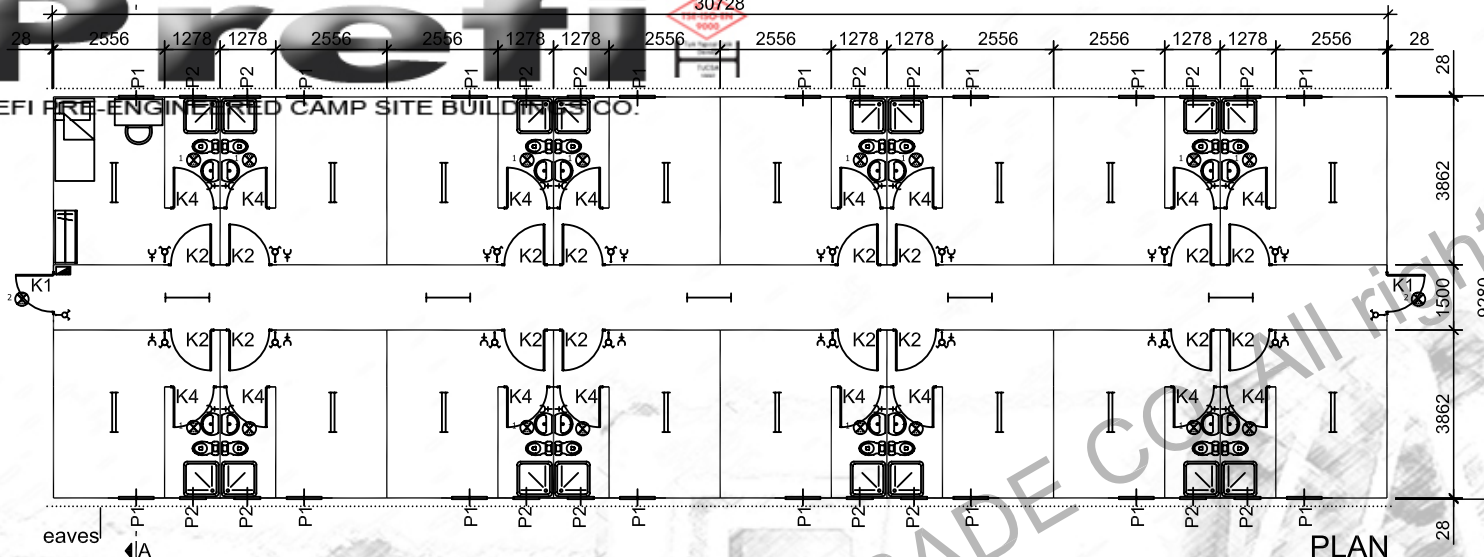

0.50 mm. Trapezoidal Galvanized steel Sheet  
 Steel Purlin  
 Rafter  
 50mm. 14 kg/m<sup>3</sup> Glasswool Insulation  
 White Vinily Coated Gypsum Board

External Surfaces 0.70 mm Thickness  
 Coll-coated Painted  
 PVC Film Coated Galvanize Steel.  
 50 mm 14 kg/m<sup>3</sup> Thickness Glasswool  
 Box Profile And/Or Specially Formed Profiles  
 Internal Wall Clad 8 mm Thickness Cement  
 Bounded Particular Panel

P1	WINDOW	800x1100
P2	WINDOW	600x400
K1	EX. DOOR	850x2000
K2	IN. DOOR	840x2000
K3	EX. DOOR	1760x2000
K4	IN. DOOR	740x2000
⊕	SWITCH	
⊕	DOUBLE SWITCH	
— —	1 X 40 TMS ARMATURE	
— — —	2 X 40 TMS ARMATURE	
⊕	LATERAL EARTH SOCKET	
⊕	TELEPHONE	
⊕	C TYPE GLOBE	
⊕	C TYPE GLOBE WITH WIRE GUARD	
⊕	(220V) SURFACE MOUNTING FUSE BOX	

ALL MEASURED IN MILLIMETERS

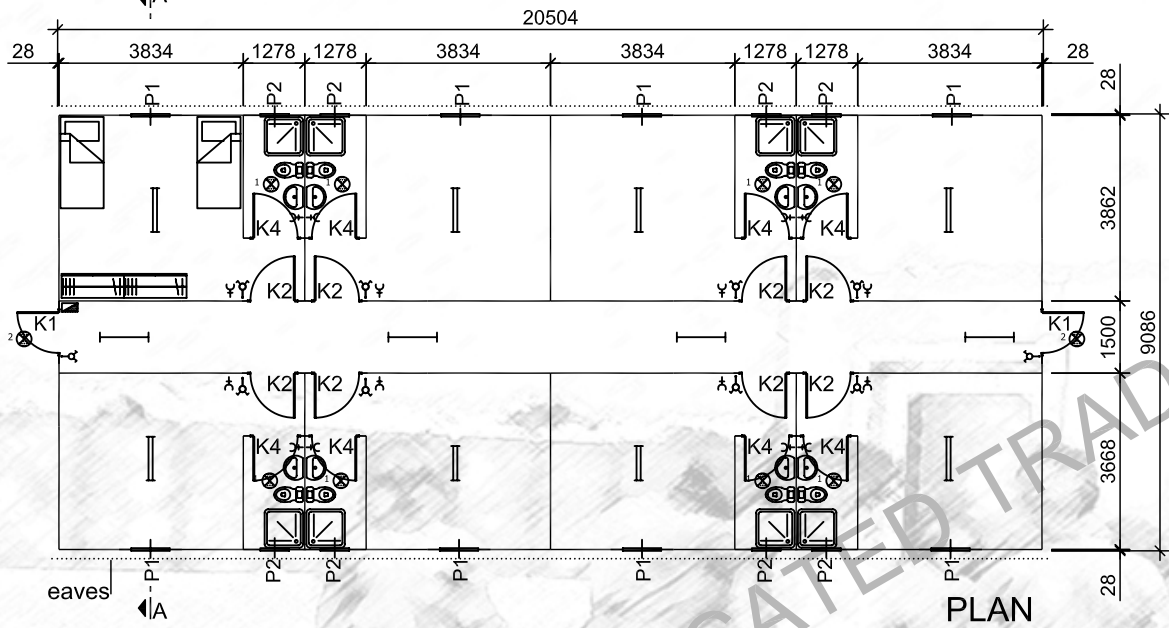

PLAN

P1	WINDOW	800x1100
P2	WINDOW	600x400
K1	EX. DOOR	850x2000
K2	IN. DOOR	840x2000
K3	EX. DOOR	1760x2000
K4	IN. DOOR	740x2000
⊖	SWITCH	
⊖	DOUBLE SWITCH	
—	1 X 40 TMS ARMATURE	
—	2 X 40 TMS ARMATURE	
⊕	LATERAL EARTH SOCKET	
☎	TELEPHONE	
⊗	C TYPE GLOBE	
⊗	C TYPE GLOBE WITH WIRE GUARD	
⊗	(220V) SURFACE MOUNTING FUSE BOX	
ALL MEASURED IN MILLIMETERS		

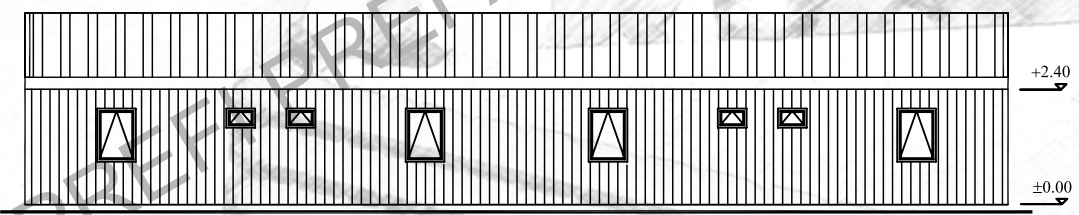

VIEW



A-A SECTION

External Surfaces 0.70 mm Thickness  
Coll-coated Painted  
PVC Film Coated Galvanize Steel.  
50 mm 14 kg/m<sup>3</sup> Thickness Glasswool  
Box Profile And/Or Specially Formed Profiles  
Internal Wall Clad 8 mm Thickness Cement  
Bounded Particular Panel

2 UNIT

# Prefi



PREFI PRE-ENGINEERED CAMP SITE BUILDINGS CO.

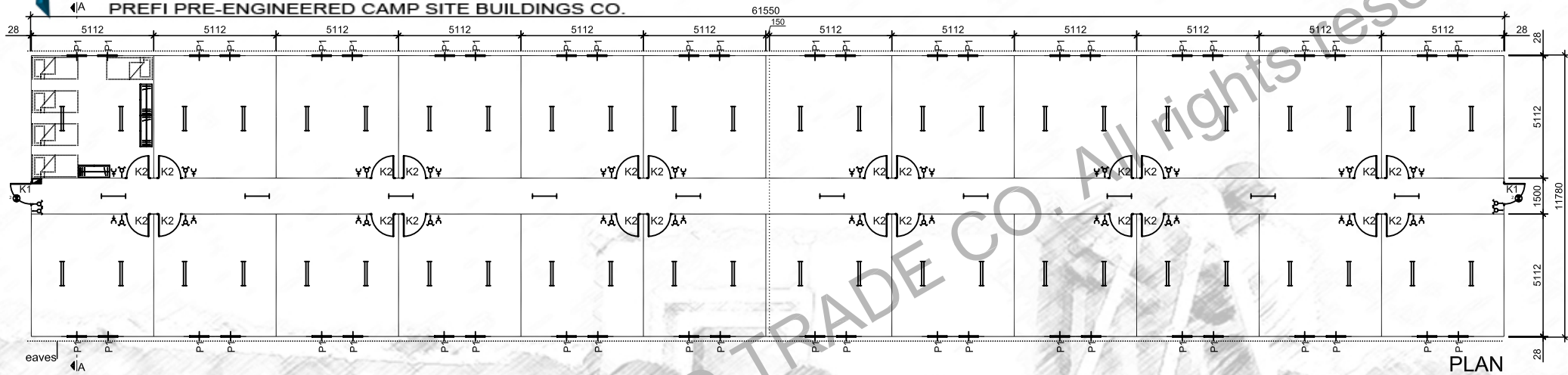

PLAN

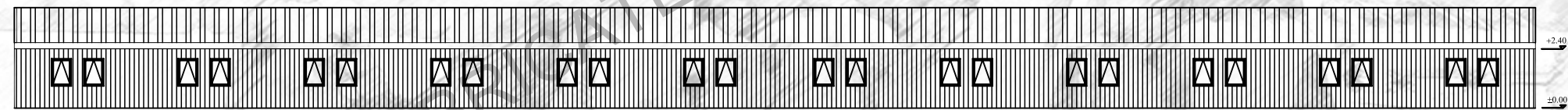

VIEW

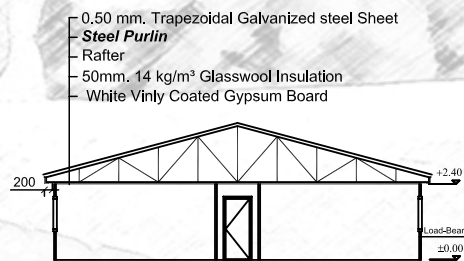

A-A SECTION

External Surfaces 0.70 mm Thickness  
Cold-coated Painted  
PVC Film Coated Galvanize Steel.  
±50 mm 14 kg/m<sup>3</sup> Thickness Glasswool  
Box Profile And/Or Specially Formed Profiles  
Internal Wall Clad 8 mm Thickness Cement  
Bounded Particular Panel

P1	WINDOW	800x1100
P2	WINDOW	600x400
K1	EX. DOOR	850x2000
K2	IN. DOOR	840x2000
K3	EX. DOOR	1760x2000
K4	IN. DOOR	740x2000
—	SWITCH	
—	DOUBLE SWITCH	
—	1 X 40 TMS ARMATURE	
—	2 X 40 TMS ARMATURE	
—	LATERAL EARTH SOCKET	
—	TELEPHONE	
—	C TYPE GLOBE	
—	C TYPE GLOBE WITH WIRE GUARD	
—	(220V) SURFACE MOUNTING FUSE BOX	
ALL MEASURED IN MILLIMETERS		

# Prefi

PREFABRİK YAPI END. BİLİŞİM ve TİCARET LTD.ŞTİ.  
Ankara - İstanbul Karayolu, 30. km  
Akıncı Kavşağı, Kazan 06980 Ankara  
Tef:+90(312) 814 40 92(Pbx) Fax:+90(312) 814 40 97  
www.Prefi.com.tr e-posta: prefiprefi@prefiprefi.com

ÇİZEN:  
DRAWN:KONTROL:  
CHK:ONAYLAMA:  
APPROVAL:

H.VAKUR YILMAZYİĞİT

FİRMA /COMPANY:

500 PERSON CAMP

TARİH/DATE:

BAŞLIK /TITLE:

240 PERSON WORKER DORMITORY

GLV-BET ( ALTERNATIVE - 1 )

REFERANS:

REV.NO:

SAYFA /PAGE:

4/16

2  
m

725.05

F.MI.06/B

YAYIN TARİHİ : 01/08/2001

REVİZYON TARİHİ : 07/03/2007

2 UNIT

# Prefi



PREFI PRE-ENGINEERED CAMP SITE BUILDINGS CO.

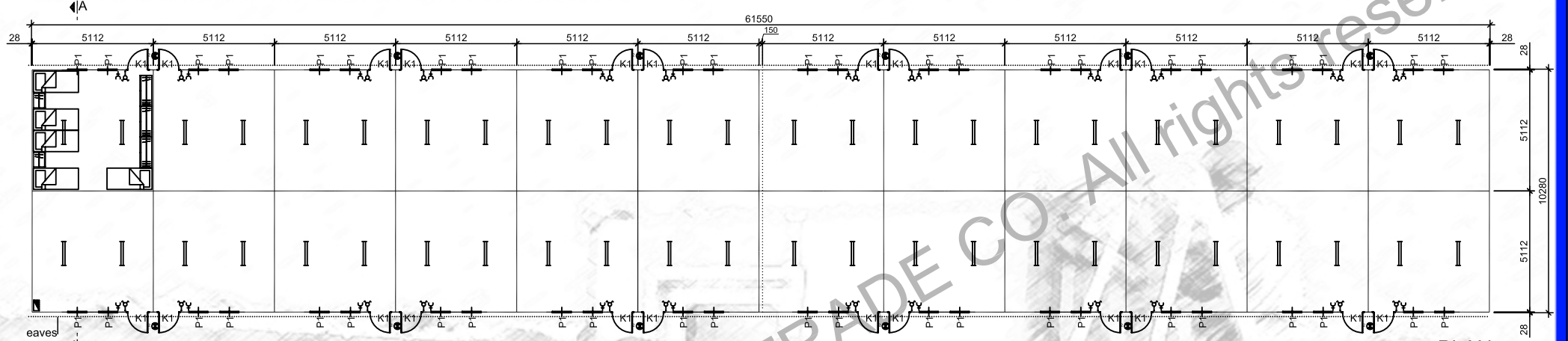

PLAN

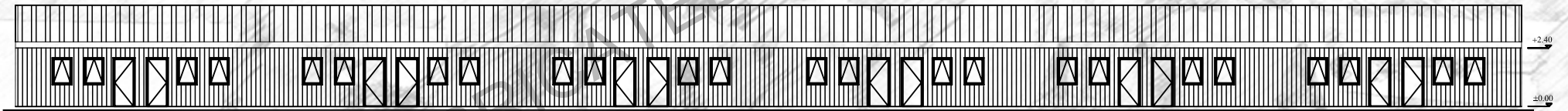

VIEW

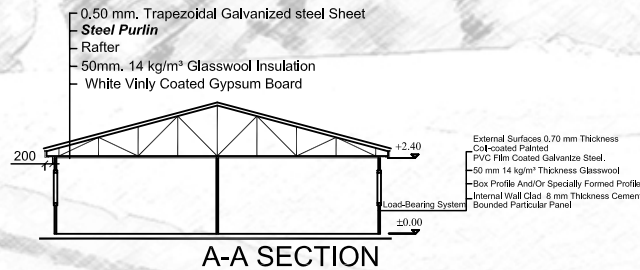

A-A SECTION

P1	WINDOW	800x1100
P2	WINDOW	600x400
K1	EX. DOOR	850x2000
K2	IN. DOOR	840x2000
K3	EX. DOOR	1780x2000
K4	IN. DOOR	740x2000
	SWITCH	
	DOUBLE SWITCH	
	1 X 40 TMS ARMATURE	
	2 X 40 TMS ARMATURE	
	LATERAL EARTH SOCKET	
	TELEPHONE	
	C TYPE GLOBE	
	C TYPE GLOBE WITH WIRE GUARD	
	(220V) SURFACE MOUNTING FUSE BOX	
ALL MEASURED IN MILLIMETERS		

# Prefi

PREFABRIK YAPI END. BİLİŞİM ve TİCARET LTD.ŞTİ.  
 Ankara - İstanbul Karayolu, 30. km  
 Akıncı Kavşağı, Kazan 06980 Ankara  
 Tel:+90(312) 814 40 92(Pbx) Fax:+90(312) 814 40 97  
 www.Prefi.com.tr e-posta: prefipref.com

ÇİZEN:  
 DRAWN:

KONTROL:  
 CHK:

ONAYLAMA:  
 APPROVAL: H.VAKUR YILMAZYİĞİT

FİRMA /COMPANY:

500 PERSON CAMP

TARİH/DATE:

BAŞLIK /TITLE:

240 PERSON WORKER DORMITORY

GLV-BET ( ALTENATIVE - 2 )

REFERANS:

REV.NO:

SAYFA /PAGE:

2  
m

632.73

5/16

F.MI.06/B

YAYIN TARİHİ : 01/08/2001

REVİZYON TARİHİ : 07/03/2007

2 UNIT

# Prefi

PREFI PRE-ENGINEERED CAMP SITE BUILDINGS CO.

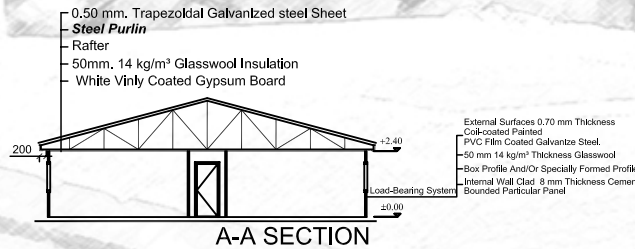
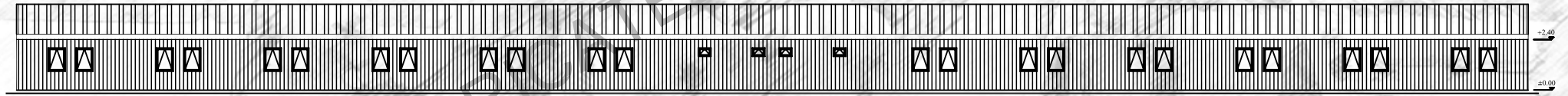
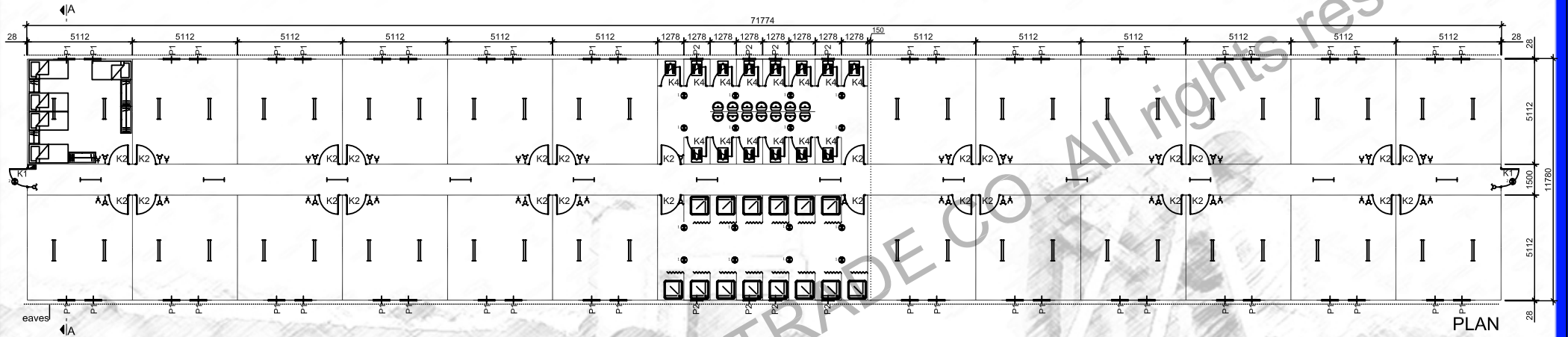

P1	WINDOW	800x1100
P2	WINDOW	600x400
K1	EX. DOOR	850x2000
K2	IN. DOOR	840x2000
K3	EX. DOOR	1760x2000
K4	IN. DOOR	740x2000
—○—	SWITCH	
—○—	DOUBLE SWITCH	
—	1 X 40 TMS ARMATURE	
—	2 X 40 TMS ARMATURE	
—C—	LATERAL EARTH SOCKET	
☎	TELEPHONE	
⊙	C TYPE GLOBE	
⊙	C TYPE GLOBE WITH WIRE GUARD	
⊞	220V/SURFACE MOUNTING FUSE BOX	
ALL MEASURED IN MILLIMETERS		

# Prefi

PREFABRIK YAPI END. BİLİŞİM ve TİCARET LTD.ŞTİ.  
 Ankara - İstanbul Karayolu, 30. km  
 Akıncı Kavşağı, Kazan 06980 Ankara  
 Tel:+90(312) 814 40 92(Pbx) Fax:+90(312) 814 40 97  
 www.Prefi.com.tr e-posta: prefipref.com

ÇİZEN:  
DRAWN:

KONTROL:  
CHK:

ONAYLAMA:  
APPROVAL: H.VAKUR YILMAZYIĞIT

FİRMA /COMPANY:

500 PERSON CAMP

TARİH/DATE:

BAŞLIK /TITLE:

240 PERSON WORKER DORMITORY

GLV-BET ( ALTERNATIVE - 3 )

REFERANS:

REV.NO:

SAYFA /PAGE:

2  
m

845.49

6/16

F.MI.06/B

YAYIN TARİHİ : 01/08/2001

REVİZYON TARİHİ : 07/03/2007

2 UNIT

# Prefi

PREFI PRE-ENGINEERED CAMP SITE BUILDINGS CO.

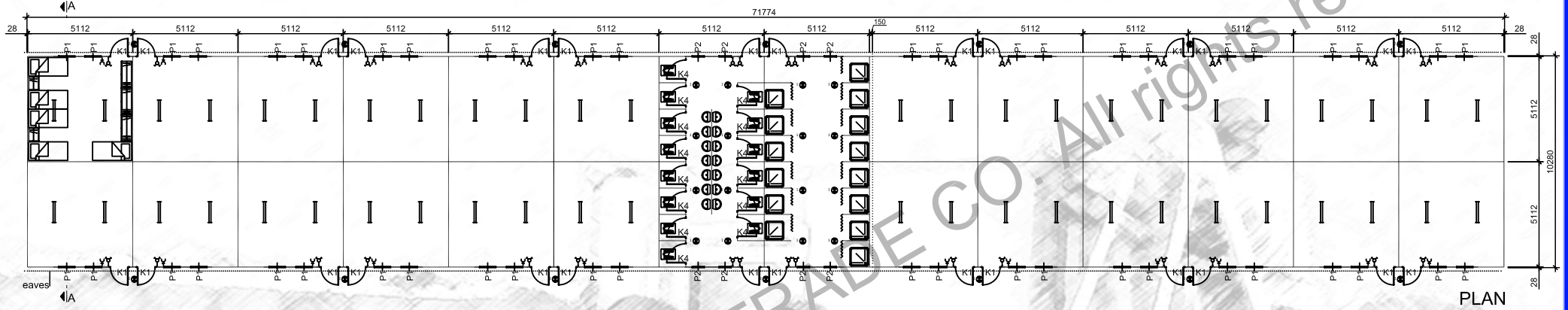

PLAN



VIEW

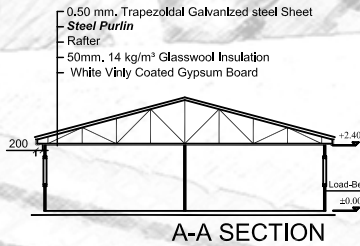

A-A SECTION

External Surfaces 0.70 mm Thickness  
 Cold-coated Painted  
 PVC Film Coated Galvanneal Steel  
 50 mm 14 kg/m<sup>3</sup> Thickness Glasswool  
 Box Profile And/Or Specially Formed Profiles  
 Internal Wall Glad 8 mm Thickness Cement  
 Bounded Particular Panel

P1	WINDOW	800x1100
P2	WINDOW	600x400
K1	EX. DOOR	850x2000
K2	IN. DOOR	840x2000
K3	EX. DOOR	1760x2000
K4	IN. DOOR	740x2000
SW	SWITCH	
DS	DOUBLE SWITCH	
1X40	1 X 40 TMS ARMATURE	
2X40	2 X 40 TMS ARMATURE	
LE	LATERAL EARTH SOCKET	
TEL	TELEPHONE	
CG	C TYPE GLOBE	
CGW	C TYPE GLOBE WITH WIRE GUARD	
220V	220V SURFACE MOUNTING FUSE BOX	

ALL MEASURED IN MILLIMETERS

# Prefi

PREFABRIK YAPI END. BİLİŞİM ve TİCARET LTD.ŞTİ.  
 Ankara - İstanbul Karayolu, 30. km  
 Akıncı Kavşağı, Kazan 06980 Ankara  
 Tel:+90(312) 814 40 92(Pbx) Fax:+90(312) 814 40 97  
 www.Prefi.com.tr e-posta: prefipref.com

ÇİZEN:  
 DRAWN:

KONTROL:  
 CHK:

ONAYLAMA:  
 APPROVAL: H.VAKUR YILMAZYİĞİT

FİRMA /COMPANY:

500 PERSON CAMP

TARİH/DATE:

BAŞLIK /TITLE:

240 PERSON WORKER DORMITORY

GLV-BET ( ALTERNATIVE - 4 )

REFERANS:

REV.NO:

SAYFA /PAGE:

2  
 m

737.83

7/16

F.MI.06/B

YAYIN TARİHİ : 01/08/2001

REVİZYON TARİHİ : 07/03/2007

2 UNIT

# Prefi

PREFI PRE-ENGINEERED CAMP SITE BUILDINGS CO.

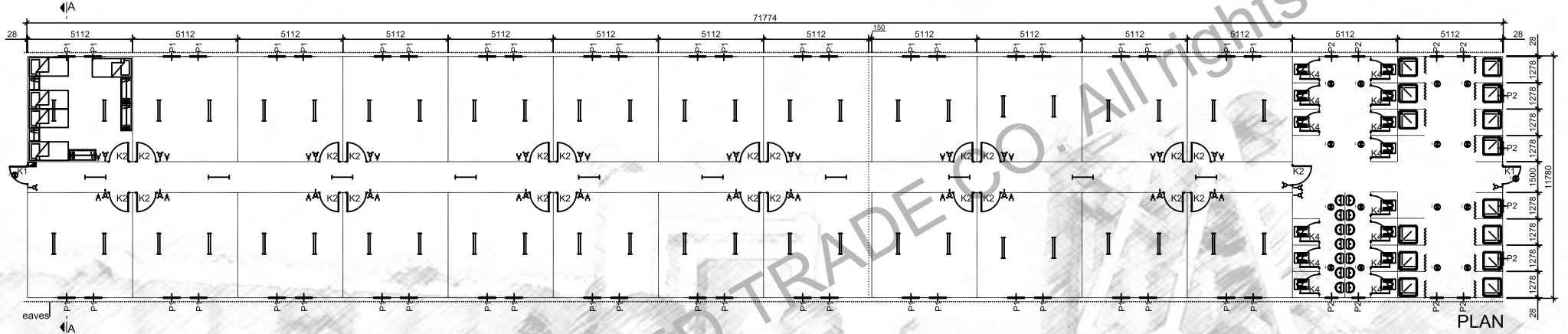

PLAN

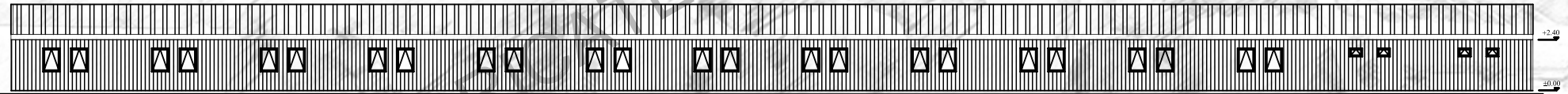

VIEW

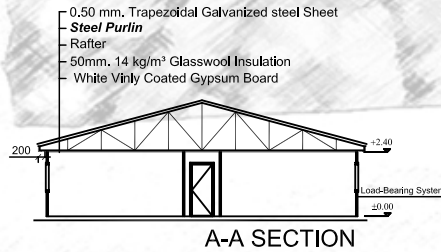

0.50 mm. Trapezoidal Galvanized steel Sheet  
 Steel Purlin  
 Rafter  
 50mm. 14 kg/m<sup>3</sup> Glasswool Insulation  
 White Vinly Coated Gypsum Board

External Surfaces 0.70 mm Thickness  
 Col-coated Painted  
 PVC Film Coated Galvanize Steel  
 50 mm 14 kg/m<sup>3</sup> Thickness Glasswool  
 Box Profile And/Or Specially Formed Profiles  
 Internal Wall Clad 8 mm Thickness Cement  
 Bounded Particular Panel

P1	WINDOW	800x1100
P2	WINDOW	600x400
K1	EX. DOOR	850x2000
K2	IN. DOOR	840x2000
K3	EX. DOOR	1760x2000
K4	IN. DOOR	740x2000
⊖	SWITCH	
⊕	DOUBLE SWITCH	
⊕	1 X 40 TMS ARMATURE	
⊕	2 X 40 TMS ARMATURE	
⊕	LATERAL EARTH SOCKET	
⊕	TELEPHONE	
⊕	C TYPE GLOBE	
⊕	C TYPE GLOBE WITH WIRE GUARD	
⊕	⊕220V/SURFACE MOUNTING FUSE BOX	

ALL MEASURED IN MILLIMETERS

# Prefi

PREFABRIK YAPI END. BİLİŞİM ve TİCARET LTD.ŞTİ.  
 Ankara - İstanbul Karayolu, 30. km  
 Akıncı Kavşağı, Kazan 06980 Ankara  
 Tel:+90(312) 814 40 92(Pbx) Fax:+90(312) 814 40 97  
 www.Prefi.com.tr e-posta: prefipref.com

ÇİZEN:  
 DRAWN:

KONTROL:  
 CHK:

ONAYLAMA:  
 APPROVAL: H.VAKUR YILMAZYİĞİT

FİRMA /COMPANY:

500 PERSON CAMP

TARİH/DATE:

BAŞLIK /TITLE:

240 PERSON WORKER DORMITORY

REFERANS:

REV.NO:

SAYFA /PAGE:

2  
 m

845.49

8/16

# Prefi

20504



PREFI PRE-ENGINEERED CAMP SITE BUILDINGS CO.

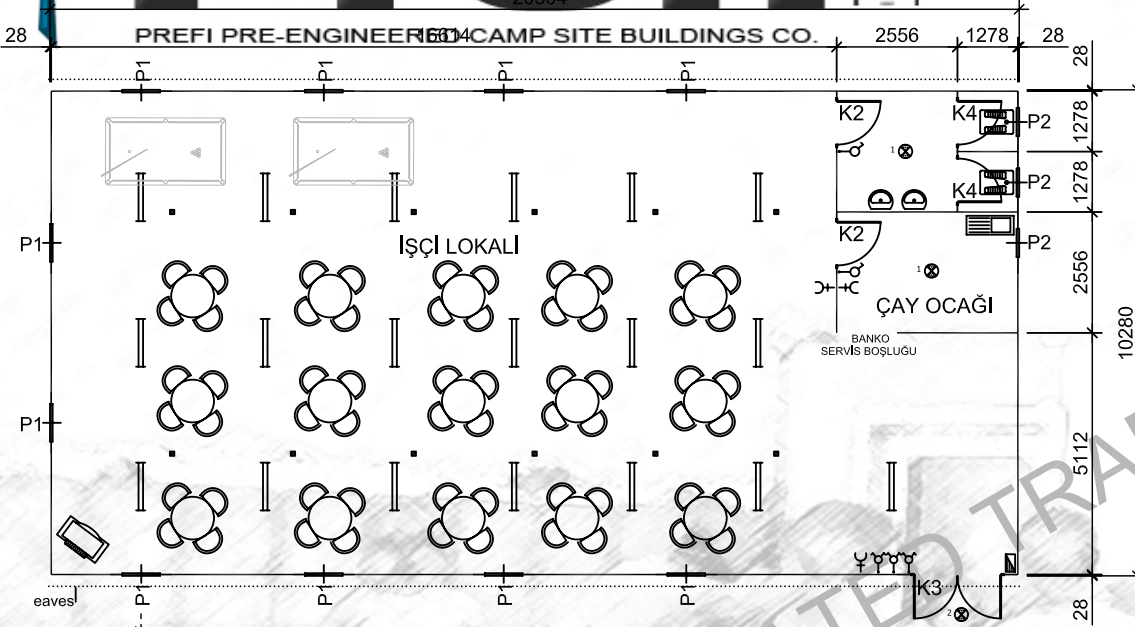

PLAN

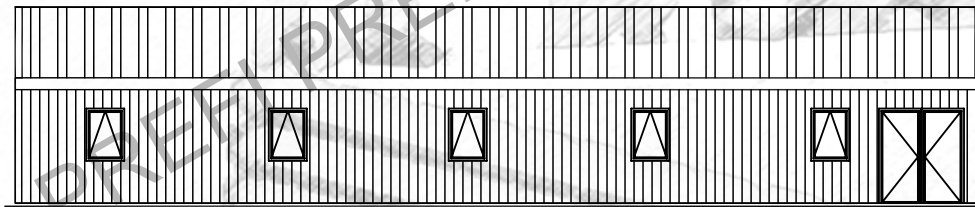

VIEW

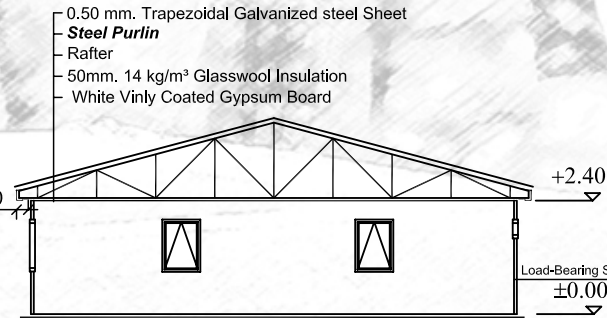

A-A SECTION

P1	WINDOW	800x1100
P2	WINDOW	600x400
K1	EX. DOOR	850x2000
K2	IN. DOOR	840x2000
K3	EX. DOOR	1760x2000
K4	IN. DOOR	740x2000
SW	SWITCH	
DS	DOUBLE SWITCH	
1 X 40 TMS	1 X 40 TMS ARMATURE	
2 X 40 TMS	2 X 40 TMS ARMATURE	
LE	LATERAL EARTH SOCKET	
T	TELEPHONE	
1	C TYPE GLOBE	
2	C TYPE GLOBE WITH WIRE GUARD	
F	(220V) SURFACE MOUNTING FUSE BOX	

ALL MEASURED IN MILLIMETERS

- 0.50 mm. Trapezoidal Galvanized steel Sheet
- Steel Purlin
- Rafter
- 50mm. 14 kg/m<sup>3</sup> Glasswool Insulation
- White Vinyl Coated Gypsum Board

- External Surfaces 0.70 mm Thickness Co<sup>2</sup>-coated Painted
- PVC Film Coated Galvanize Steel.
- 50 mm 14 kg/m<sup>3</sup> Thickness Glasswool
- Box Profile And/Or Specialty Formed Profiles
- Internal Wall Clad. 8 mm Thickness Cement Bounded Particular Panel

## Prefi

PREFABRİK YAPI END. BİLİŞİM ve TİCARET LTD.ŞTİ.  
Ankara - İstanbul Karayolu, 30. km  
Akıncı Kavşağı, Kazan 06980 Ankara  
Tel:90(312) 814 40 92(Pbx) Fax:90(312) 814 40 97  
www.Prefi.com.tr e-posta: prefiprefi.com

ÇİZEN:  
DRAWN:  
KONTROL:  
CHK:  
ONAYLAMA:  
APPROVAL: H. VAKUR YILMAZYİĞİT

FİRMA / COMPANY:  
**500 PERSON CAMP**  
TARİH/DATE:

BAŞLIK / TITLE: **WORKER LOCAL BUILDING**  
**(GLV-BET)**  
REFERANS:  
REV.NO:  
SAYFA / PAGE:

2  
m<sup>2</sup>  
210.78  
9/16

# Prefi

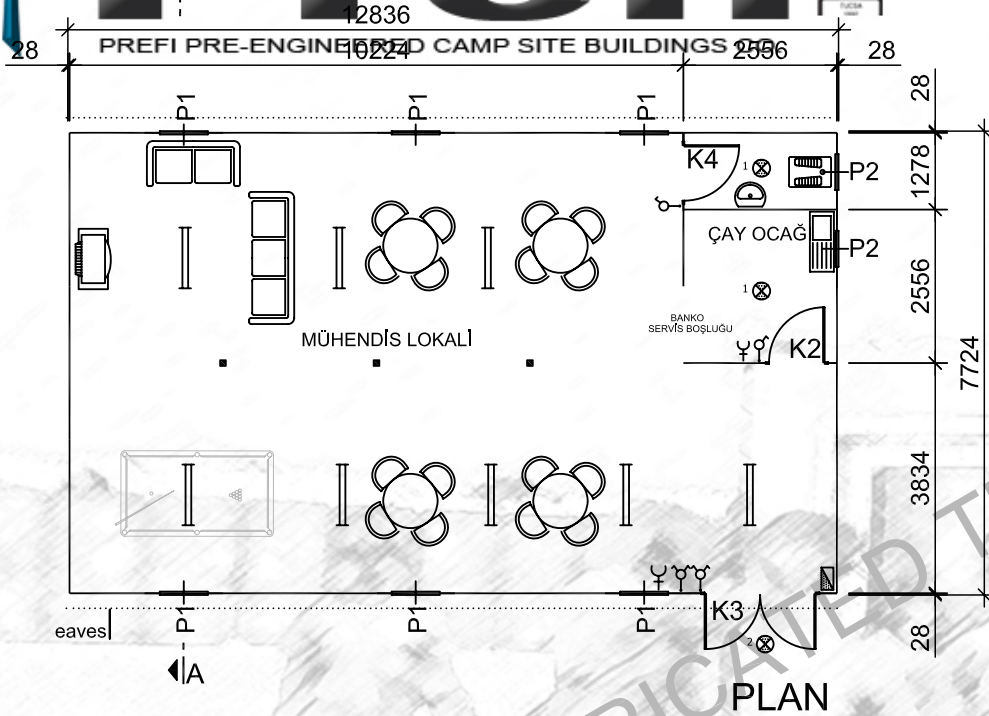

PLAN

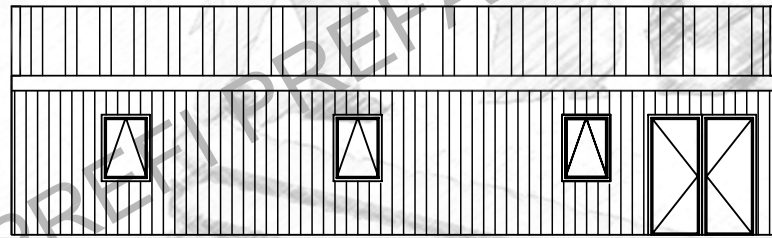

VIEW

0.50 mm. Trapezoidal Galvanized steel Sheet  
Steel Purlin  
Rafter  
50mm. 14 kg/m<sup>3</sup> Glasswool Insulation  
White Vinly Coated Gypsum Board

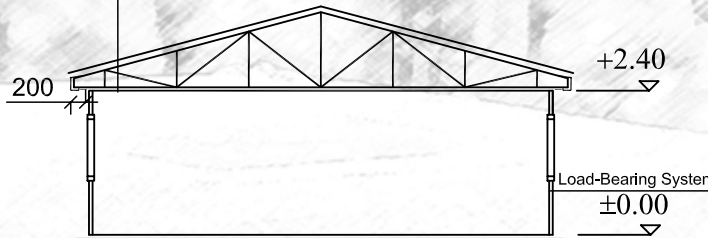

A-A SECTION

External Surfaces 0.70 mm Thickness  
Coil-coated Painted  
PVC Film Coated Galvanize Steel.  
50 mm 14 kg/m<sup>3</sup> Thickness Glasswool  
Box Profile And/Or Specially Formed Profiles  
Internal Wall Clad 8 mm Thickness Cement  
Bounded Particular Panel

P1	WINDOW	800x1100
P2	WINDOW	600x400
K1	EX. DOOR	850x2000
K2	IN. DOOR	840x2000
K3	EX. DOOR	1760x2000
K4	IN. DOOR	740x2000
⊕	SWITCH	
⊕	DOUBLE SWITCH	
—	1 X 40 TMS ARMATURE	
—	2 X 40 TMS ARMATURE	
—C	LATERAL EARTH SOCKET	
⊕	TELEPHONE	
⊕	C TYPE GLOBE	
⊕	C TYPE GLOBE WITH WIRE GUARD	
⊕	(220V)SURFACE MOUNTING FUSE BOX	
ALL MEASURED IN MILLIMETERS		

# Prefi

PREFABRİK YAPI END. BİLİŞİM ve TİCARET LTD.ŞTİ.  
Ankara - İstanbul Karayolu, 30. km  
Akıncı Kavşağı, Kazan 06980 Ankara  
Tel:90(312) 814 40 92(Pbx) Fax:90(312) 814 40 97  
www.Prefi.com.tr e-posta: prefipref.com

ÇİZEN:  
DRAWN:

KONTROL:  
CHK:

ONAYLAMA:  
APPROVAL: H. VAKUR YILMAZYİĞİT

FİRMA /COMPANY:

500 PERSON CAMP

TARİH/DATE:

BAŞLIK /TITLE: ENGINEER LOCAL BUILDING

(GLV-BET)

REFERANS:

REV.NO:

SAYFA /PAGE:

2  
m

99.14

10/16

# Prefi

PREFI PRE-ENGINEERED CAMP SITE BUILDINGS CO.

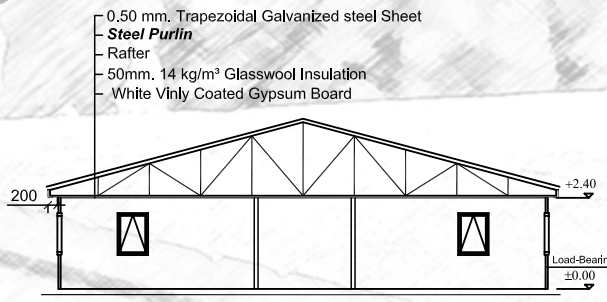
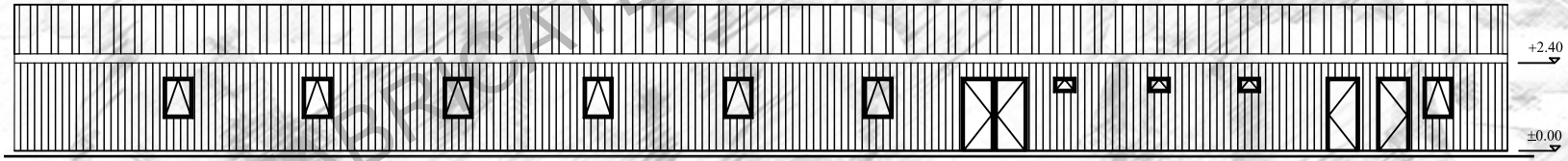
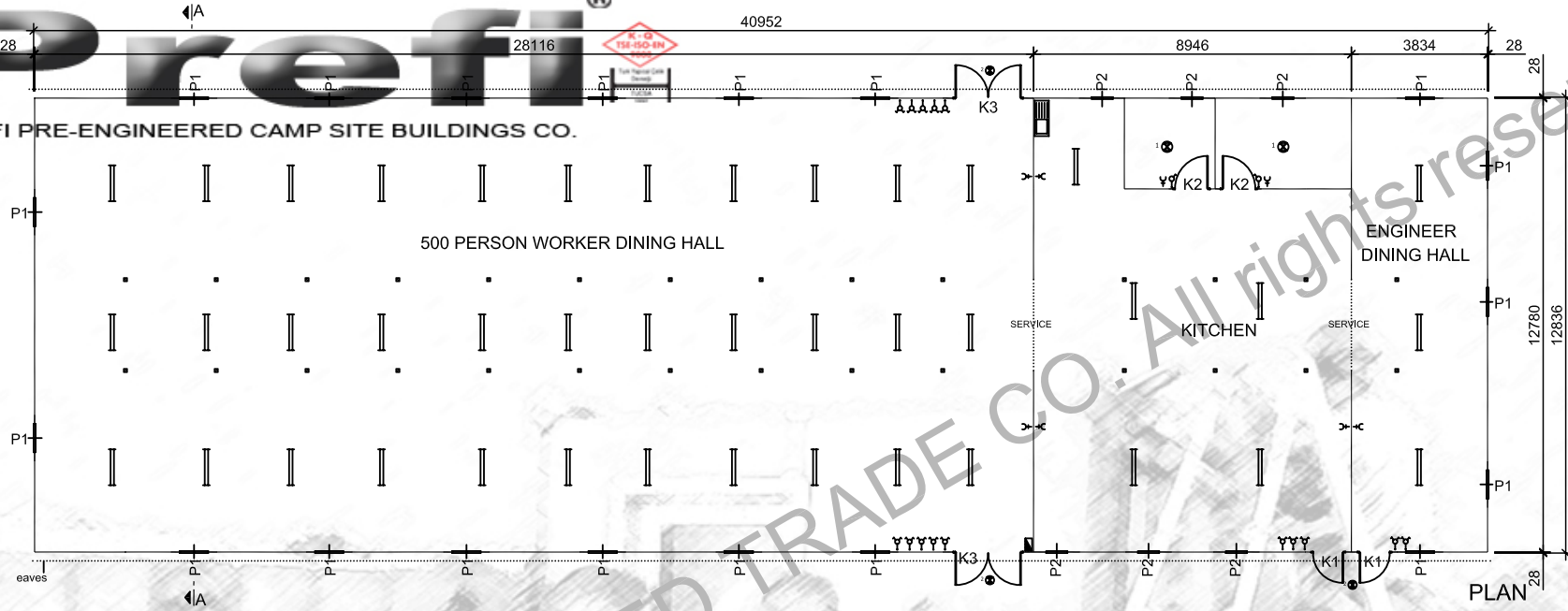

0.50 mm. Trapezoidal Galvanized steel Sheet  
**Steel Purlin**  
- Rafter  
- 50mm, 14 kg/m<sup>3</sup> Glasswool Insulation  
- White Vinly Coated Gypsum Board

External Surfaces 0.70 mm Thickness  
Coll-coated Painted  
PVC Film Coated Galvanize Steel,  
-50 mm 14 kg/m<sup>3</sup> Thickness Glasswool  
-Box Profile And/Or Specially Formed Profiles  
Internal Wall Clad 8 mm Thickness Cement  
Bounded Particular Panel

P1	WINDOW	800x1100
P2	WINDOW	600x400
K1	EX. DOOR	850x2000
K2	IN. DOOR	840x2000
K3	EX. DOOR	1760x2000
K4	IN. DOOR	740x2000
SW	SWITCH	
DS	DOUBLE SWITCH	
1X40	1 X 40 TMS ARMATURE	
2X40	2 X 40 TMS ARMATURE	
LES	LATERAL EARTH SOCKET	
TEL	TELEPHONE	
CG	C TYPE GLOBE	
CGW	C TYPE GLOBE WITH WIRE GUARD	
220V	220V SURFACE MOUNTING FUSE BOX	

ALL MEASURED IN MILLIMETERS

# Prefi

PREFABRIK YAPI END. BİLİŞİM ve TİCARET LTD.ŞTİ.  
Ankara - İstanbul Karayolu, 30. km  
Akıncı Kavşağı, Kazan 06980 Ankara  
Tel:90(312) 814 40 92(Pbx) Fax:90(312) 814 40 97  
www.Prefi.com.tr e-posta: prefiprefi.com

ÇİZEN:  
DRAWN:  
KONTROL:  
CHK:  
ONAYLAMA:  
APPROVAL: H. VAKUR YILMAZYİĞİT

FİRMA /COMPANY:  
500 PERSON CAMP  
TARİH/DATE:

BAŞLIK /TITLE:  
WORKER-ENGINEER DINING HALL  
(GLV-BET)  
REFERANS:  
REV.NO:  
SAYFA /PAGE:

2  
m  
525.65  
11/16

# Prefi



PREFI PRE-ENGINEERED CAMP SITE BUILDINGS CO.

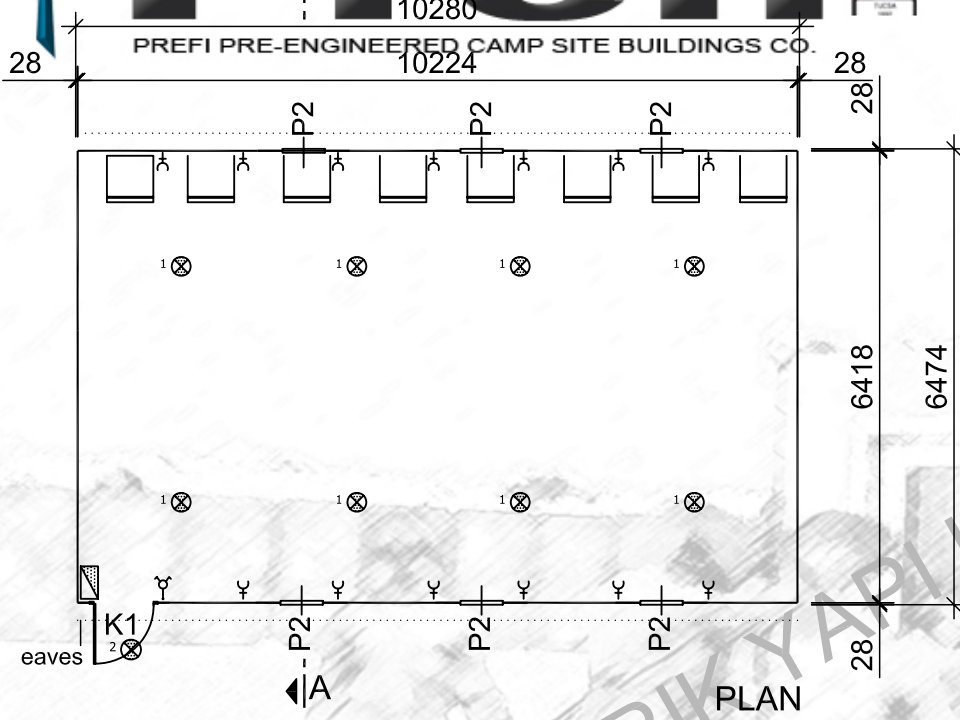

PLAN

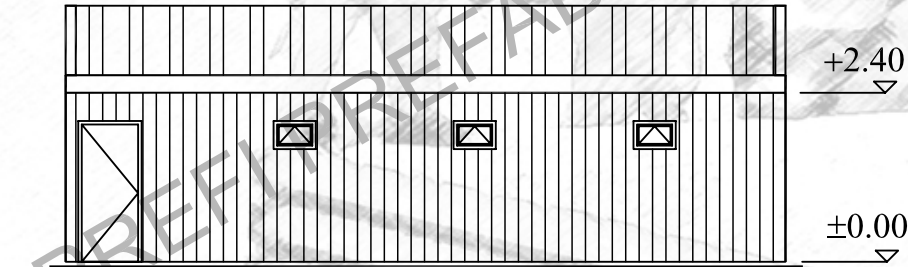

VIEW

0.50 mm. Trapezoidal Galvanized steel Sheet  
**Steel Purlin**  
Rafter  
50mm. 14 kg/m<sup>3</sup> Glasswool Insulation  
White Vinly Coated Gypsum Board



A-A SECTION

P1	PENCERE	800x1100
P2	PENCERE	600x400
K1	DIŞ KAPI	850x2000
K2	İÇ KAPI	840x2000
K3	DIŞ KAPI	1760x2000
K4	İÇ KAPI	740x2000
—○	ANAHTAR	
—○	KOMÜTATÖR	
—	1 X 40 FLORESAN ARM.	
—	2 X 40 FLORESAN ARM.	
—	4 x 18 PARABOLİK ARM.	
—C	TOPRAKLI PRİZ	
—T	TELEFON	
1 ⊗	C TİPİ ARM	
2 ⊗	C TİPİ ARM (KAFESLİ)	
—	SİGORTA KUTUSU	
Ölçüler mm. dir.		

# Prefi

PREFABRİK YAPI END. BİLİŞİM ve TİCARET LTD.ŞTİ.  
Ankara - İstanbul Karayolu, 30. km  
Akıncı Kavşağı, Kazan 06980 Ankara  
Tel:+90(312) 814 40 92(Pbx) Fax:+90(312) 814 40 97  
www.Prefi.com.tr e-posta: prefipref.com

ÇİZEN:  
DRAWN:

KONTROL:  
CHK:

ONAYLAMA:  
APPROVAL: H.VAKUR YILMAZYİĞİT

FİRMA /COMPANY:

500 PERSON CAMP

TARİH/DATE:

BAŞLIK /TITLE: LAUNDRY BUILDING

GLV-BET

REFERANS:

REV.NO:

SAYFA /PAGE:

2  
m

66.55

12/16

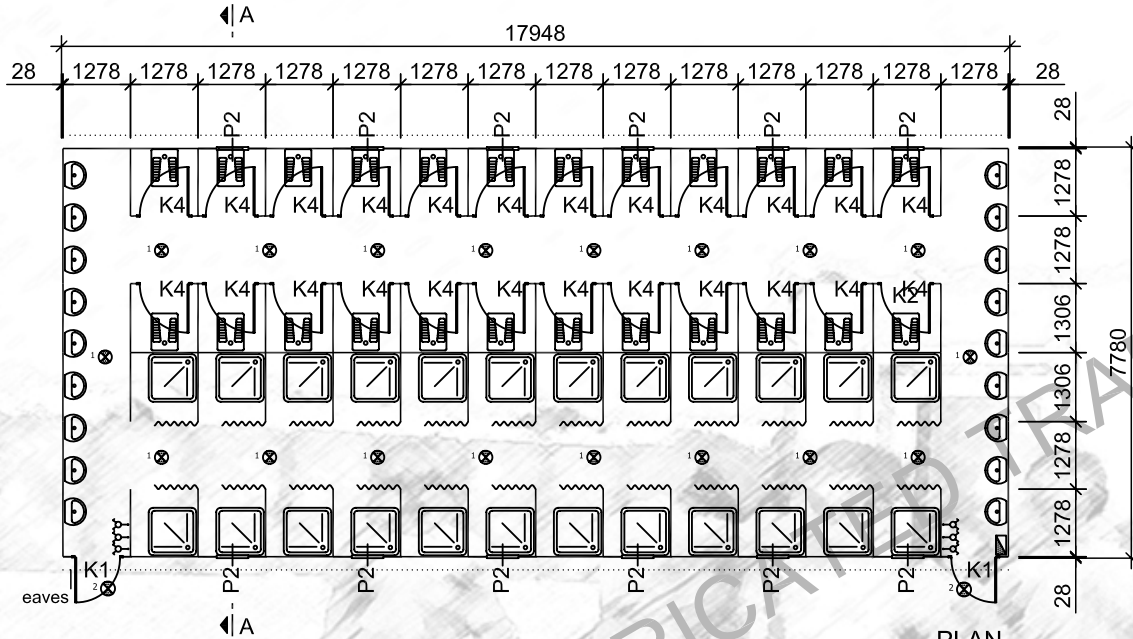

PLAN

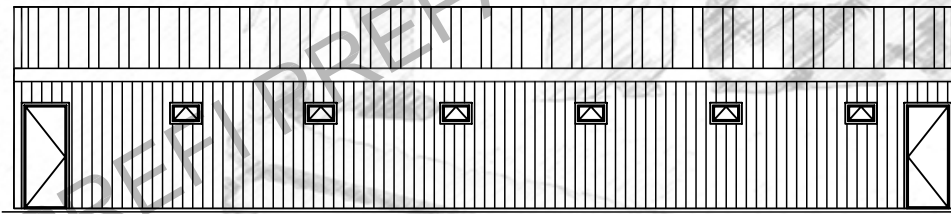

VIEW

0.50 mm. Trapezoidal Galvanized steel Sheet  
**Steel Purlin**  
 Rafter  
 50mm. 14 kg/m<sup>3</sup> Glasswool Insulation  
 White Vinyly Coated Gypsum Board

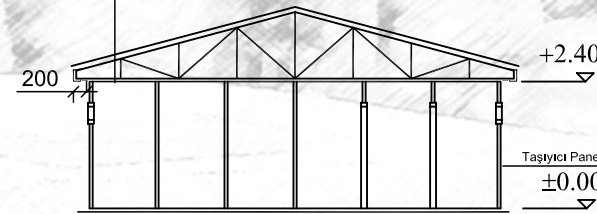

A-A SECTION

Dış Kaplama 0,70 mm Kalınlığında Özel Şekilendirilmiş  
 Coil-coated Boyalı  
 PVC Film Kaplı Galvanize Sac  
 50mm. 14 kg/m<sup>3</sup> Glasswool Insulation  
 Kütü Profil / Özel Büküm DKP Sac Taşıyıcı Panel Strüktürü  
 İç Kaplama 8 mm Kalınlığında  
 Çimentolu Yonga Levha

P1	WINDOW	800x1100
P2	WINDOW	600x400
K1	EX. DOOR	850x2000
K2	IN. DOOR	840x2000
K3	EX. DOOR	1760x2000
K4	IN. DOOR	740x2000
SW	SWITCH	
DS	DOUBLE SWITCH	
1X40	1 X 40 TMS ARMATURE	
2X40	2 X 40 TMS ARMATURE	
LES	LATERAL EARTH SOCKET	
T	TELEPHONE	
1C	C TYPE GLOBE	
2C	C TYPE GLOBE WITH WIRE GUARD	
MF	(220V)SURFACE MOUNTING FUSE BOX	
ALL MEASURED IN MILLIMETERS		

1 2 3 4 5 6 7 8 9 10

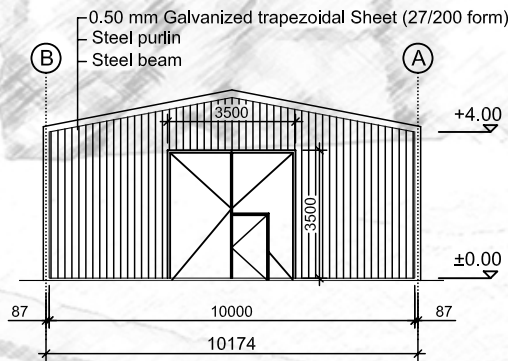
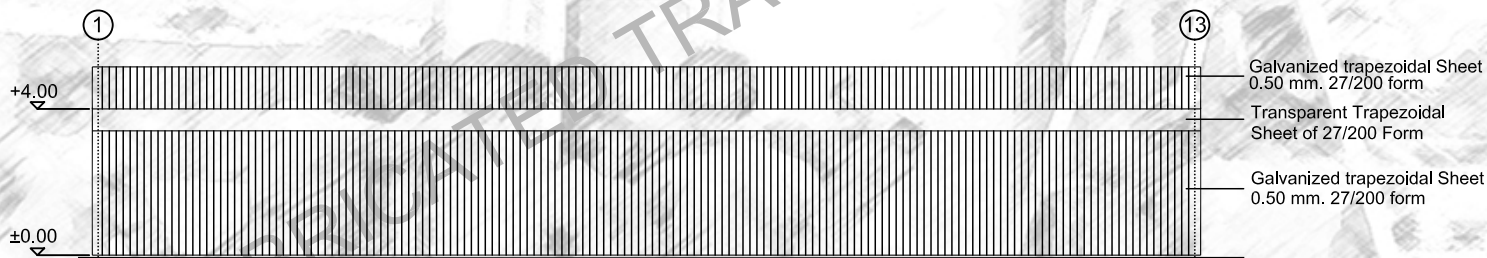
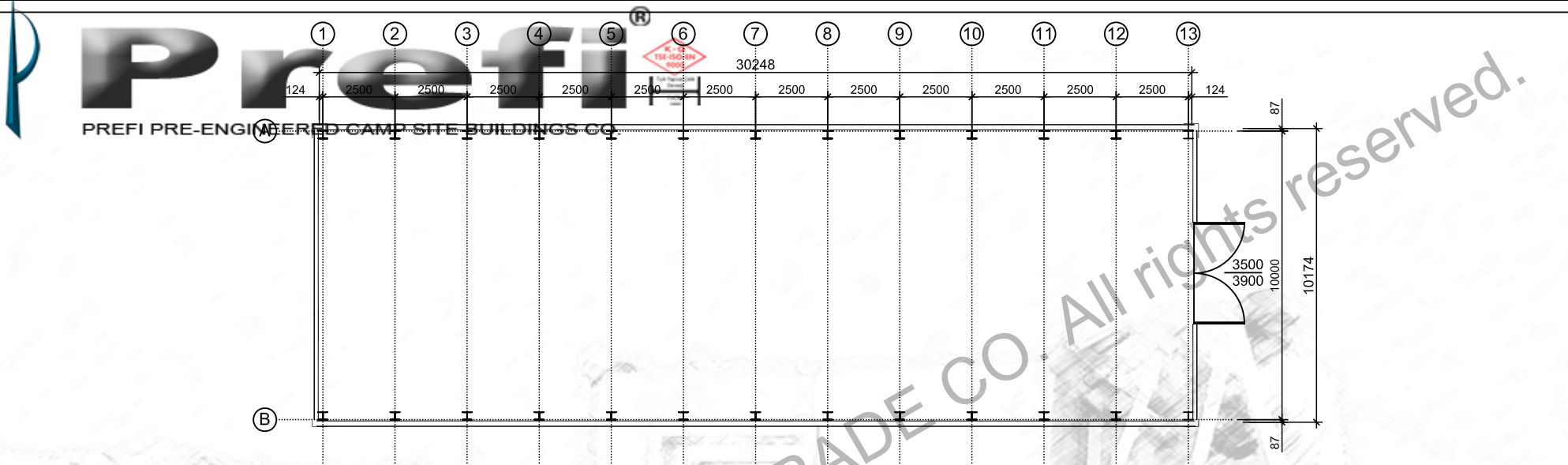

**P r e f i**

PREFABRİK YAPI END. BİLİŞİM ve TİCARET LTD.ŞTİ.  
Ankara - İstanbul Karayolu, 30. km  
Akıncı Kavşağı, Kazan 06980 Ankara  
Tel:90(312) 814 40 92(Pbx) Fax:90(312) 814 40 97  
www.Prefi.com.tr e-posta: prefipref.com

ÇİZEN:  
DRAWN:

KONTROL:  
CHK:

ONAYLAMA:  
APPROVAL: H. VAKUR YILMAZYİĞİT

FİRMA /COMPANY:

500 PERSON CAMP

TARİH/DATE:

BAŞLIK /TITLE:

WAREHOSUE ( 1 )

REFERANS:

REV.NO:

SAYFA /PAGE:

2  
m  
307.74

14/16

1 2 3 4 5 6 7 8 9 10

# Prefi

PREFABRİK YAPILAR VE MÜHÜRLEME VE TİCARİT LTD. ŞTİ.



40248

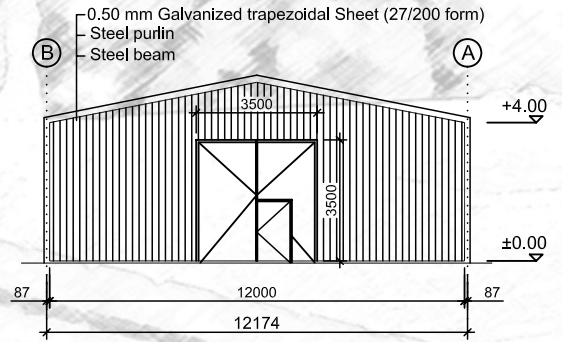
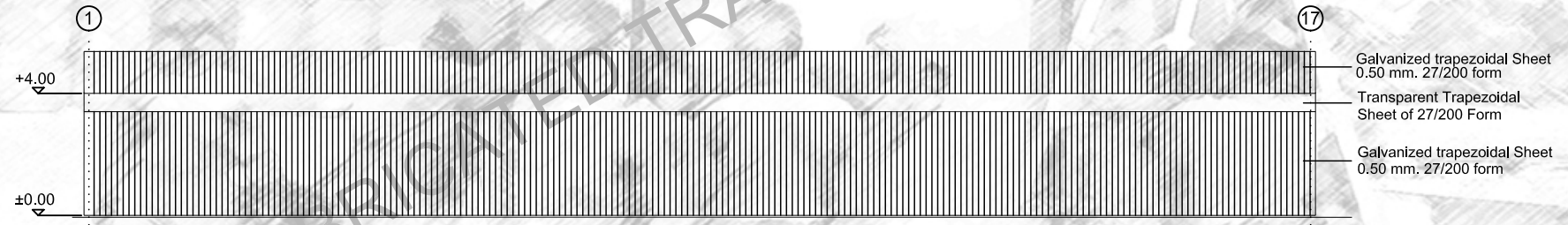
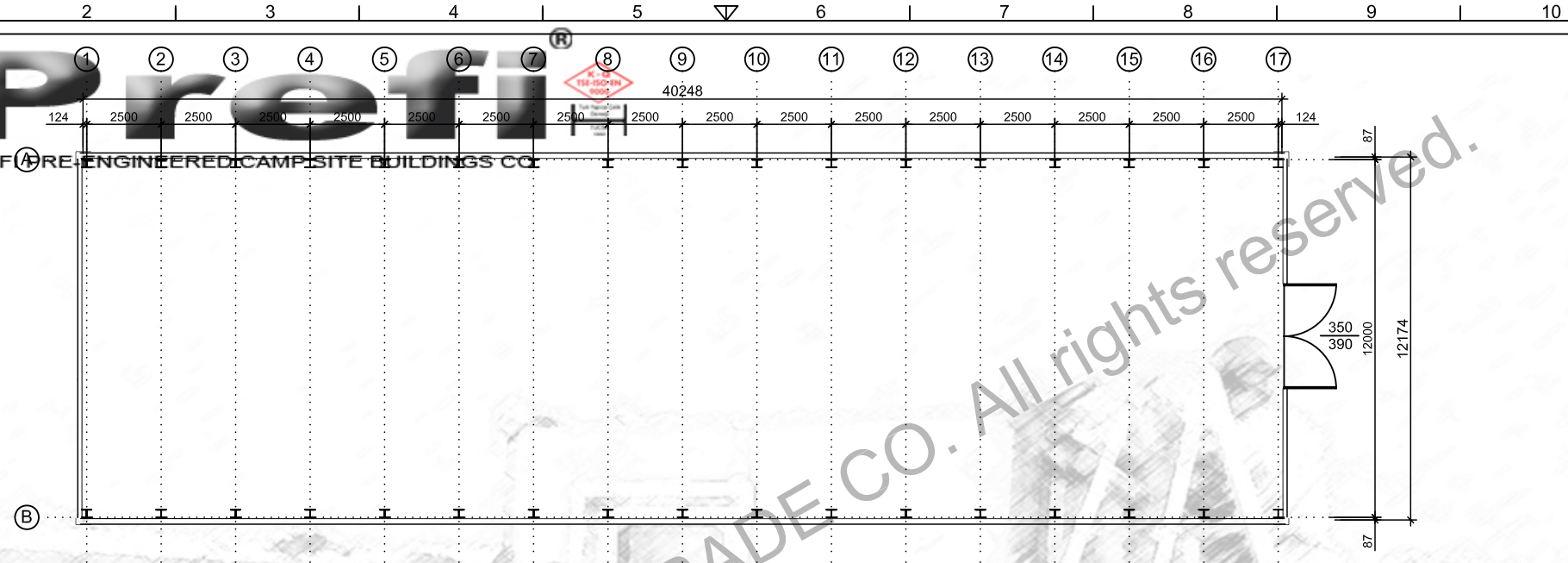

# Prefi

PREFABRİK YAPILAR VE MÜHÜRLEME VE TİCARİT LTD. ŞTİ.  
Ankara - İstanbul Karayolu, 30. km  
Akıncı Kavşağı, Kazan 06980 Ankara  
Tel:90(312) 814 40 92(Pbx) Fax:90(312) 814 40 97  
www.Prefi.com.tr e-posta: prefipref.com

ÇİZEN:  
DRAWN:  
KONTROL:  
CHK:  
ONAYLAMA:  
APPROVAL: H. VAKUR YILMAZYİĞİT

FİRMA /COMPANY:  
500 PERSON CAMP  
TARİH/DATE:

BAŞLIK /TITLE:  
WAREHOUSE ( 2 )  
REFERANS:  
REV.NO:  
SAYFA /PAGE:  
15/16

2  
m  
489.97

2 UNIT

# Prefi

2000

PREFI PRE-ENGINEERED CAMP SITE BUILDINGS CO.

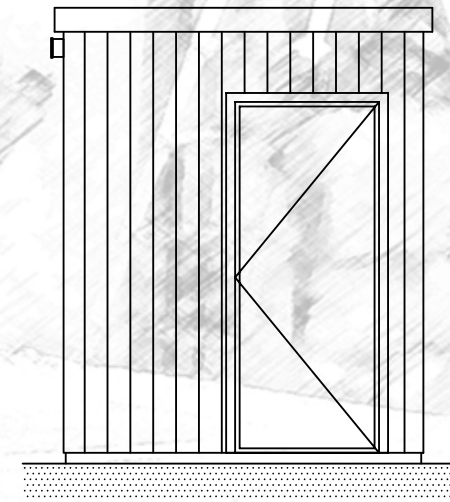
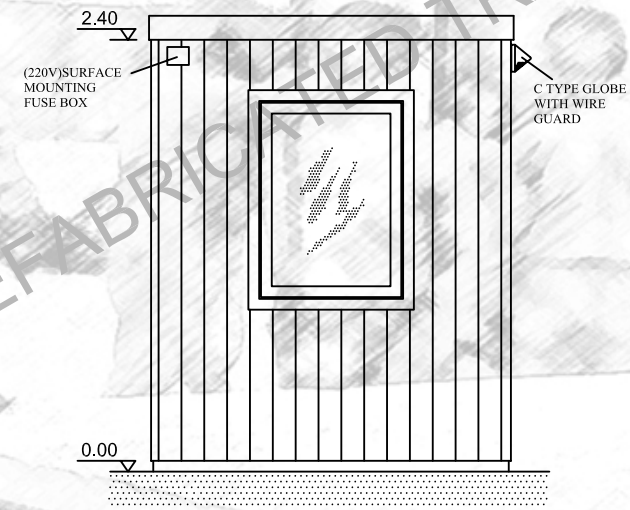
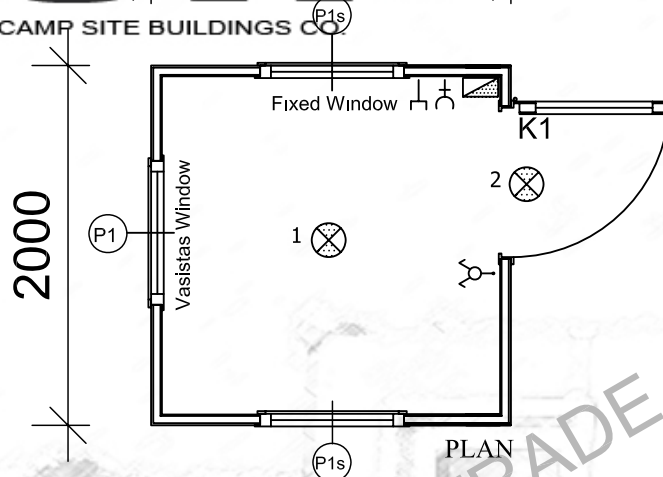

P1	WINDOW	800x1100
P2	WINDOW	600x400
K1	EX. DOOR	850x2000
K2	IN. DOOR	840x2000
K3	EX. DOOR	1760x2000
K4	IN. DOOR	740x2000
⊖	SWITCH	
⊖	DOUBLE SWITCH	
—	1 X 40 TMS ARMATURE	
—	2 X 40 TMS ARMATURE	
⊕	LATERAL EARTH SOCKET	
☎	TELEPHONE	
1 ⊗	C TYPE GLOBE	
2 ⊗	C TYPE GLOBE WITH WIRE GUARD	
⊖	(220V) SURFACE MOUNTING FUSE BOX	
ALL MEASURED IN MILLIMETERS		

## Prefi

PREFABRIK YAPI END. BİLİŞİM ve TİCARET LTD.ŞTİ.  
Ankara - İstanbul Karayolu, 30. km  
Akıncı Kavşağı, Kazan 06980 Ankara  
Tel:90(312) 814 40 92(Pbx) Fax:90(312) 814 40 97  
www.prefipref.com e-posta: prefipref@prefipref.com

ÇİZEN:  
DRAWN:KONTROL:  
CHK:ONAYLAMA:  
APPROVAL: H.VAKUR YILMAZYİĞİT

FİRMA /COMPANY:

500 PERSON CAMP

TARİH/DATE:

BAŞLIK /TITLE:

SECTORY (TİP A-A2-A2020 3P)

REFERANS:

REV.NO:

SAYFA /PAGE:

2  
m

4.0

16/16

F.MI.06/B

YAYIN TARİHİ : 01/08/2001

REVİZYON TARİHİ : 07/03/2007

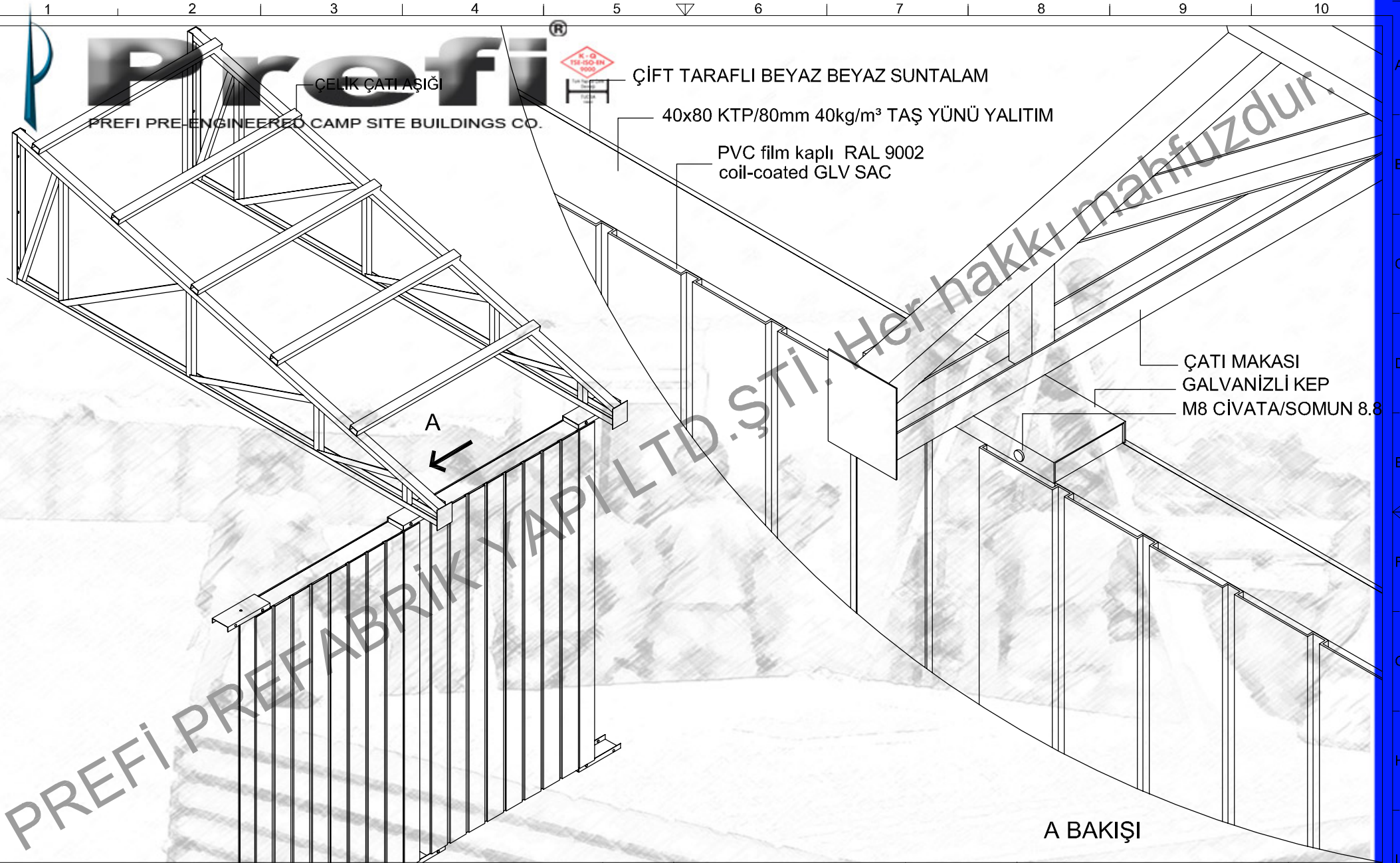

**Prefi**

PREFİ PREFABRİK YAPI END. BİLİŞİM ve TİCARET LTD.ŞTİ.  
Ankara - İstanbul Karayolu, 30. km  
Kazan 06980 Ankara/TURKEY  
Tel:90(312) 814 40 92(Pbx) Fax:90(312) 814 40 97  
www.Prefi.com.tr e-posta: pref@prefi.com.tr

DRAWN: .....

CHK:

ONAYLAMA:  
APPROVAL: H. VAKUR YILMAZYİĞİT

FİRMA /COMPANY:

...

TARİH/DATE:

...

BAŞLIK /TITLE: GLV-SLAM

m<sup>2</sup>

80 LİK KARKASLI PANELLER

...

REFERANS:

..

REV.NO:

SAYFA /PAGE:

..

A BAKIŞI

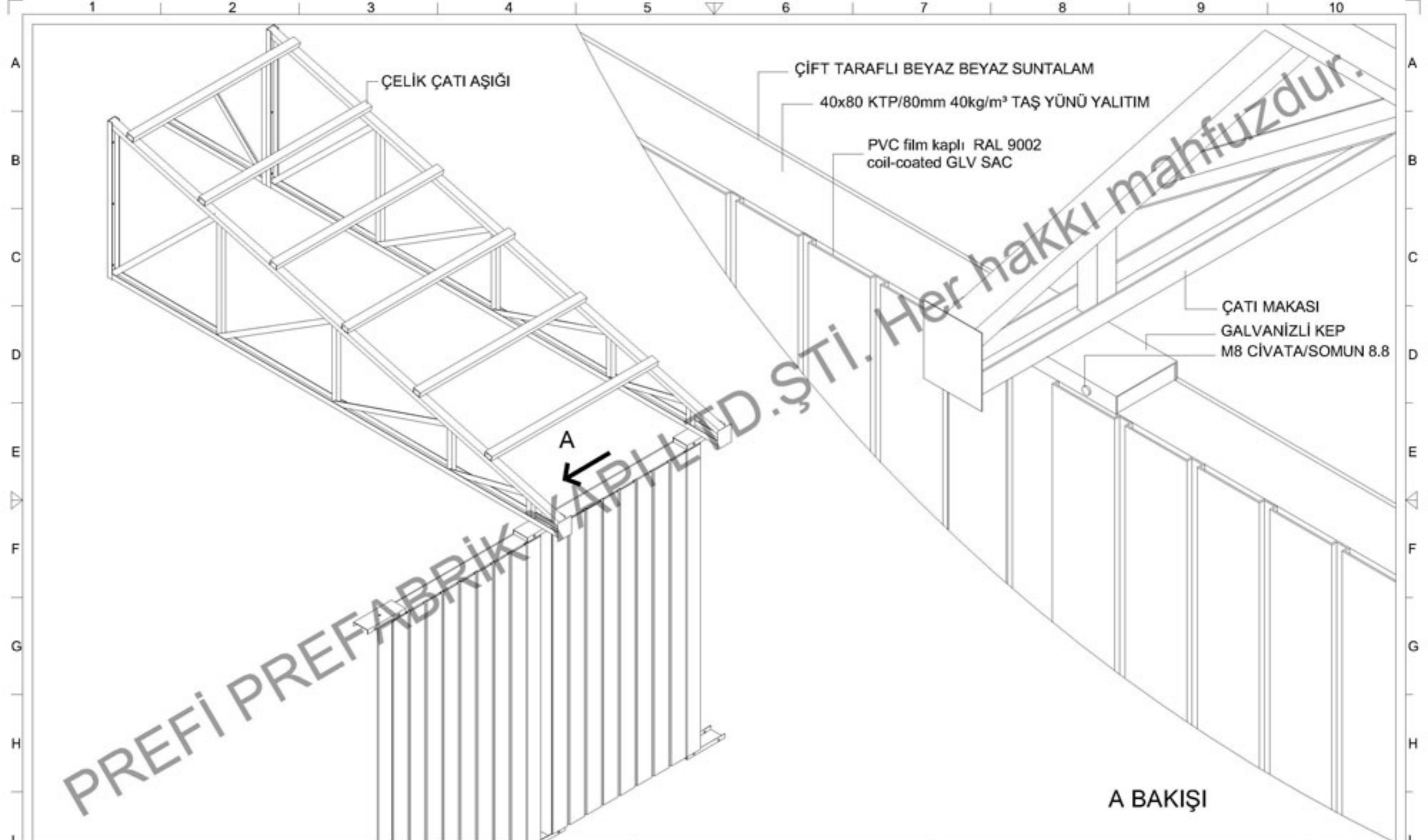

**Pre fi**

PREFİ PREFABRİK YAPI END. BİLİŞİM ve TİCARET LTD.ŞTİ.  
Ankara - İstanbul Karayolu, 30. km  
Kazan 06980 Ankara/TURKEY  
Tel:90(312) 814 40 92(Pbx) Fax:90(312) 814 40 97  
www.Prefi.com.tr e-posta: pref@prefi.com.tr

ÇİZEN:  
DRAWN: .....

KONTROL:  
CHK:

ONAYLAMA:  
APPROVAL: H. VAKUR YILMAZYİĞİT

FİRMA /COMPANY:  
...

TARİH/DATE:  
...

BAŞLIK /TITLE: GLV-BET

80 LİK KARKASLI PANELLER

REFERANS: ..

REV. NO:

SAYFA /PAGE: ..



**Prefi**  
PREFI PRE-ENGINEERED CAMP SITE BUILDINGS CO.

0.50 mm. Trapezoidal Galvanized steel Sheet  
Steel Purlin  
Rafter  
50mm. 14 kg/m<sup>3</sup> Glasswool Insulation  
White Vinyl Coated Gypsum Board

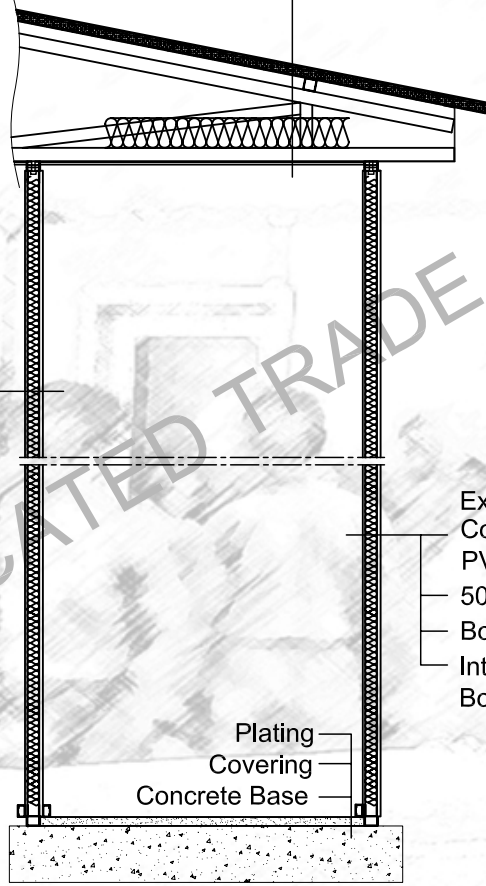

Internal Wall Clad 8 mm Thickness Cement Bounded Particular Panel  
50 mm. 14 kg/m<sup>3</sup> Thickness Glasswool  
Box Profile And/Or Specially Formed Profiles  
Internal Wall Clad 8 mm Thickness Cement Bounded Particular Panel

External Surfaces 0.70 mm Thickness Coil-coated Painted PVC Film Coated Galvanize Steel.  
50 mm. 14 kg/m<sup>3</sup> Thickness Glasswool  
Box Profile And/Or Specially Formed Profiles  
Internal Wall Clad 8 mm Thickness Cement Bounded Particular Panel

Plating  
Covering  
Concrete Base

**Prefi**

PREFABRIK YAPI END. BİLİŞİM ve TİCARET LTD.ŞTİ.  
Ankara - İstanbul Karayolu, 30. km  
Akıncı Kavşağı, Kazan 06980 Ankara  
Tel:90(312) 814 40 92(Pbx) Fax:90(312) 814 40 97  
www.Prefi.com.tr e-posta: prefipref.com

ÇİZEN:  
DRAWN:

KONTROL:  
CHK:

ONAYLAMA:  
APPROVAL:

FİRMA /COMPANY:

TARİH/DATE:

BAŞLIK /TITLE:

PANEL DETAIL

GLV - BET

m<sup>2</sup>

REFERANS:

REV.NO:

SAYFA /PAGE: