



Prefi®

PREFI PRE-ENGINEERED CAMP SITE BUILDINGS CO.



47000

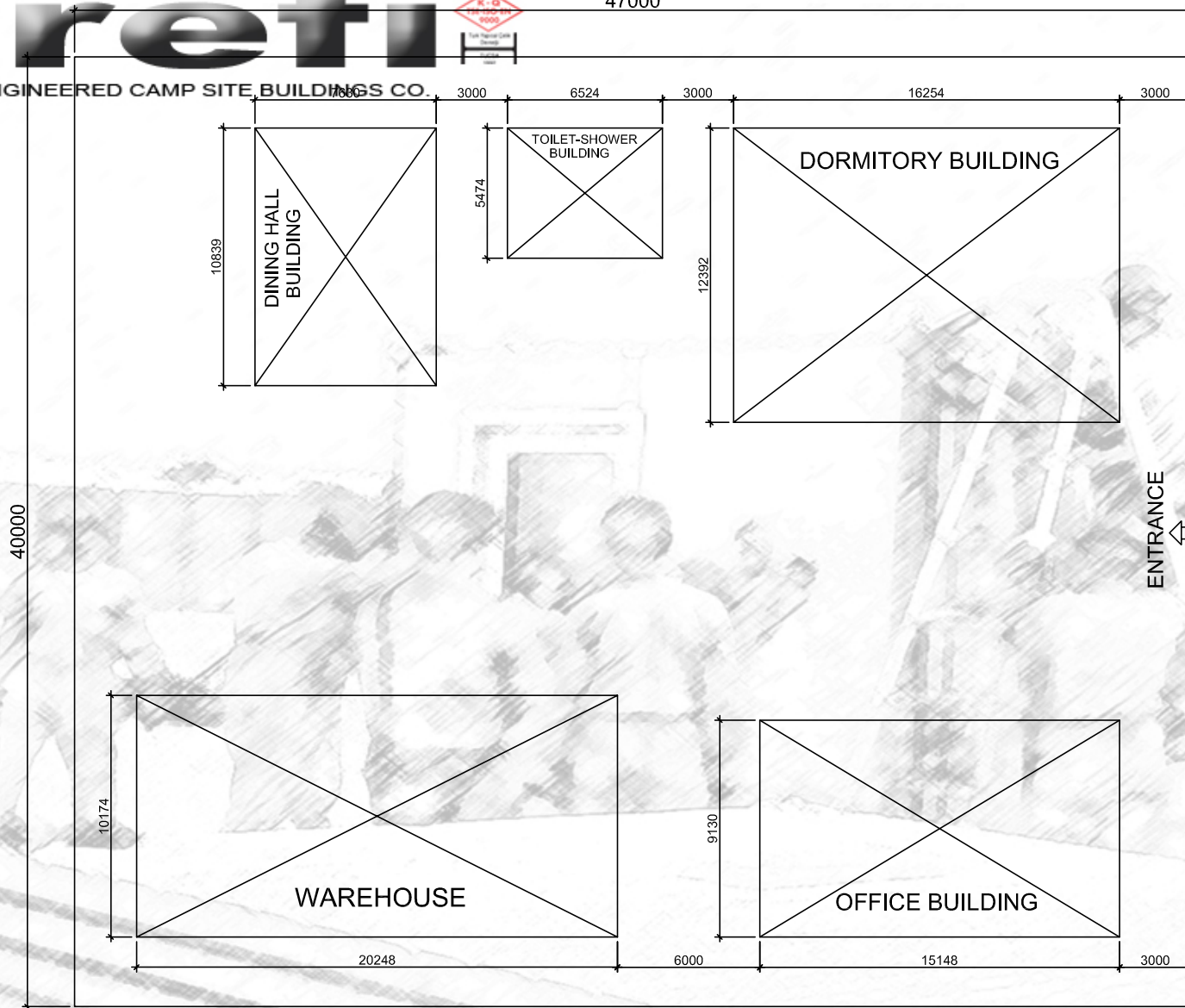

Prefi

PREFABRİK YAPI END. BİLİŞİM ve TİCARET LTD.ŞTİ.
Ankara - İstanbul Karayolu, 30. km
Akıncı Kavşağı, Kazan 06980 Ankara
Tel:90(312) 815 49 75(Pbx) Fax:90(312) 815 49 78
www.Prefi.com.tr e-posta: prefipref.com

ÇİZEN:
DRAWN:

KONTROL:
CHK:

ONAYLAMA:
APPROVAL:

FİRMA /COMPANY:

CAMP FOR 50 PERSON

TARİH/DATE:

BASLIK /TITLE:

CAMP CENTRE OF POPULATION

REFERANS:

REV.NO:

SAYFA /PAGE:

m²



	SWITCH
	DOUBLE SWITCH
	1 X 40 TMS ARMATURE
	2 X 40 TMS ARMATURE
	LATERAL EARTH SOCKET
	TELEPHONE
	C TYPE GLOBE
	C TYPE GLOBE WITH WIRE GUARD
	4 X 18 PARABOLIC ARM
	(220V) SURFACE MOUNTING FUSE BOX
	K1 850 x 2000
	K2 840 x 2000
	K3 1760 x 2000
	K4 740 x 2000
	P1 800 x 1100
	P2 600 x 400
ALL MEASURED IN MILLIMETERS	

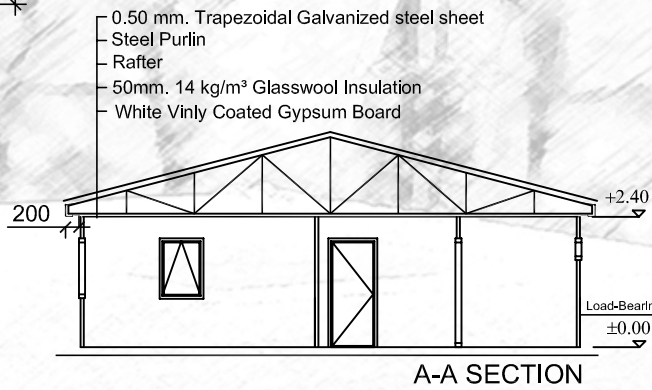
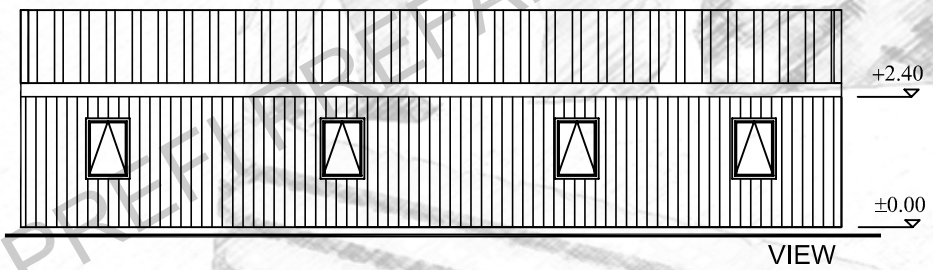
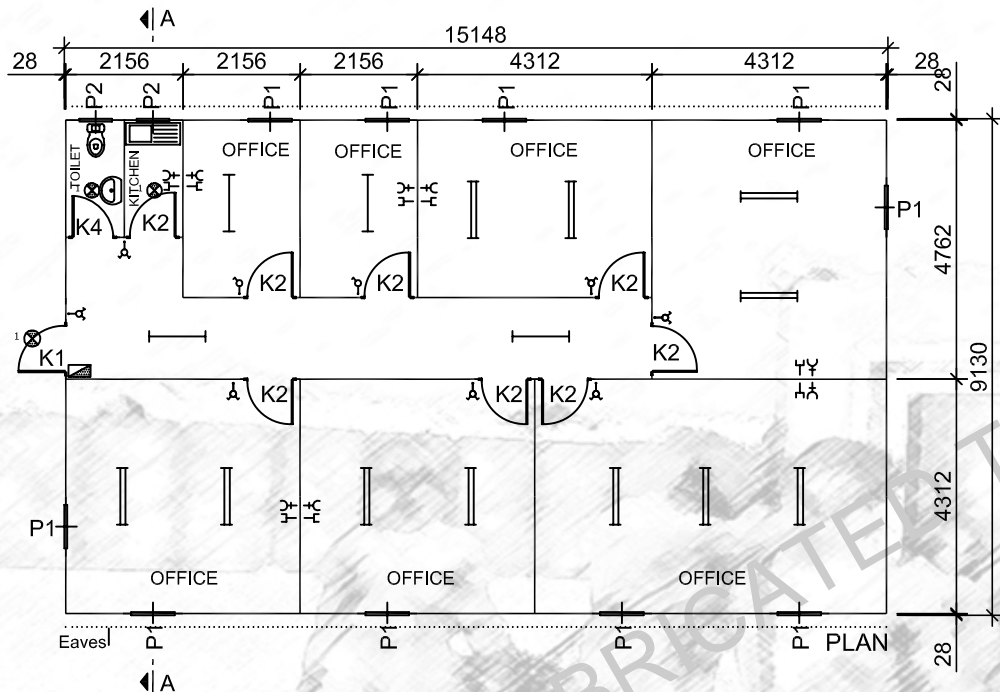

Prefi
PREFABRİK YAPI END. BİLİŞİM ve TİCARET LTD.ŞTİ.
Ankara - İstanbul Karayolu, 30. km
Akıncı Kavşağı, Kazan 06980 Ankara
Tel:+90(312) 815 49 75(Pbx) Fax:+90(312) 815 49 78
www.Prefi.com.tr e-posta: prefipref.com

ÇİZEN:
DRAWN:
KONTROL:
CHK:
ONAYLAMA:
APPROVAL:

FİRMA /COMPANY:
CAMP FOR 50 PERSON
TARİH/DATE:

BASLIK /TITLE:	OFFICE BUILDING	2
	GLV-SLAM BİNA	138.30
REFERANS:	REV.NO:	SAYFA /PAGE:
		1/5



	SWITCH
	DOUBLE SWITCH
	1 X 40 TMS ARMATURE
	2 X 40 TMS ARMATURE
	LATERAL EARTH SOCKET
	TELEPHONE
	C TYPE GLOBE
	C TYPE GLOBE WITH WIRE GUARD
	4 X 18 PARABOLIC ARM
	220V/SURFACE MOUNTING FUSE BOX
	K1 850 x 2000
	K2 840 x 2000
	K3 1760 x 2000
	K4 740 x 2000
	P1 800 x 1100
	P2 600 x 400
ALL MEASURED IN MILLIMETERS	

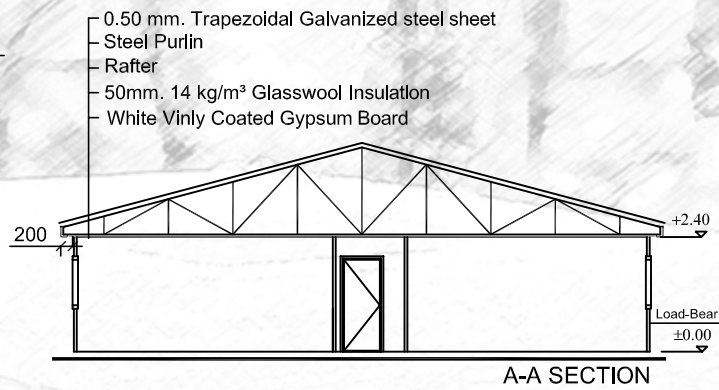
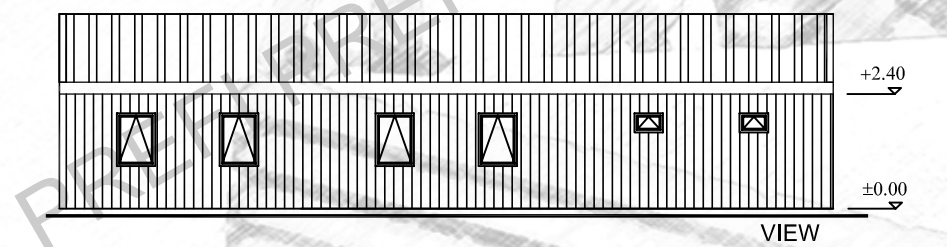
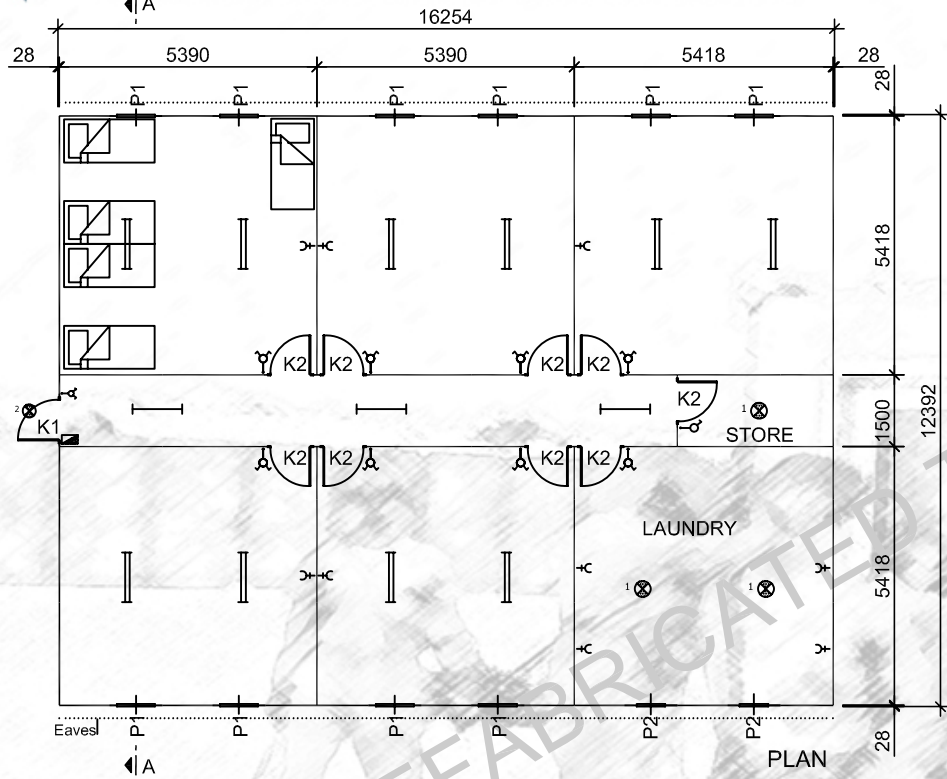

- 0.50 mm. Trapezoidal Galvanized steel sheet
- Steel Purjin
- Rafter
- 50mm. 14 kg/m³ Glasswool Insulation
- White Vinly Coated Gypsum Board

- External Surfaces 0.70 mm Thickness
- Coll-coated Painted
- PVC Film Coated Galvanize Steel.
- 50 mm 14 kg/m³ Thickness Glasswool
- Box Profile And/Or Specially Formed Profiles
- Internal Wall Clad 8 mm, Thickness, Each Sides Are White-White Laminated Chipboard



	SWITCH
	DOUBLE SWITCH
	1 X 40 TMS ARMATURE
	2 X 40 TMS ARMATURE
	LATERAL EARTH SOCKET
	TELEPHONE
	C TYPE GLOBE
	C TYPE GLOBE WITH WIRE GUARD
	4 X 18 PARABOLIC ARM
	220V/SURFACE MOUNTING FUSE BOX
	K1 650 x 2000
	K2 840 x 2000
	K3 1760 x 2000
	K4 740 x 2000
	P1 800 x 1100
	P2 800 x 400
ALL MEASURED IN MILLIMETERS	

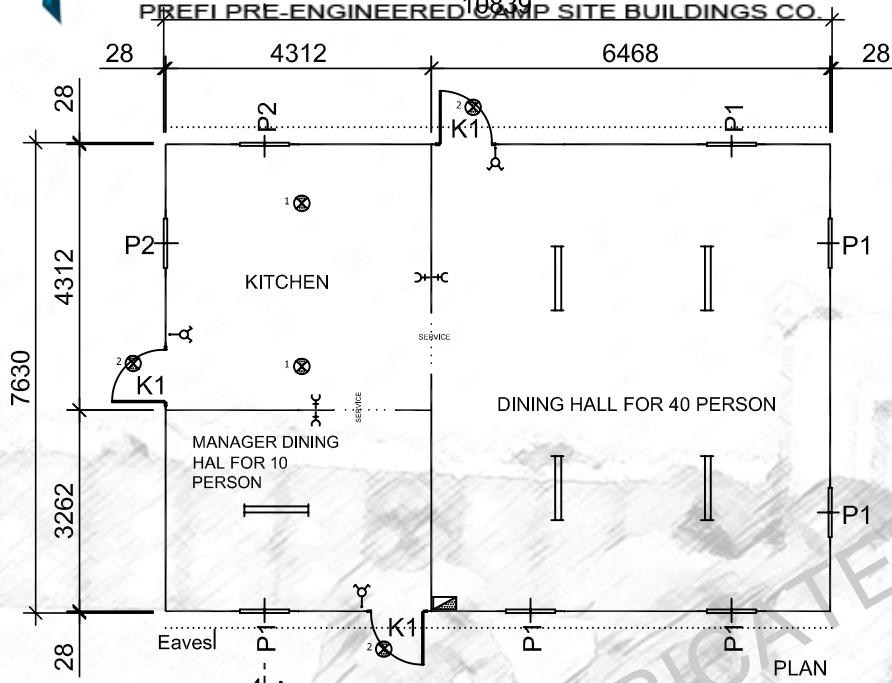

PLAN

- 0.50 mm. Trapezoidal Galvanized steel sheet
- Steel Purlin
- Rafter
- 50mm. 14 kg/m³ Glasswool Insulation
- White Vinly Coated Gypsum Board

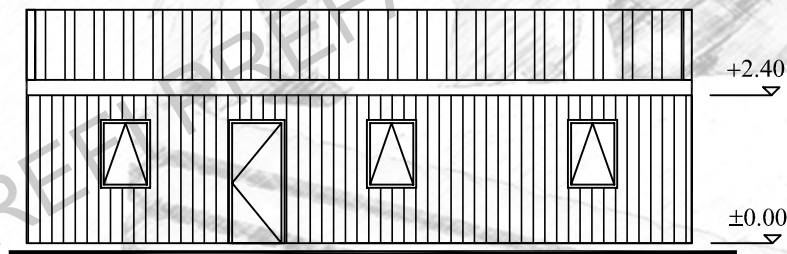

VIEW

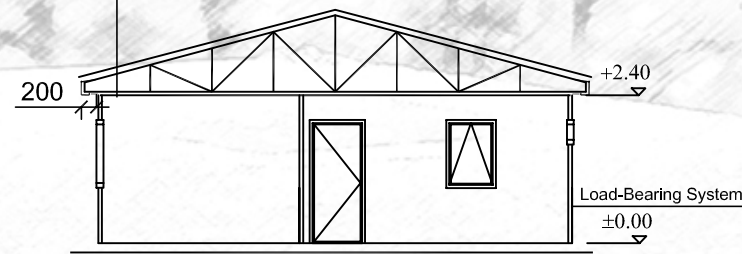

A-A SECTION

- External Surfaces 0.70 mm Thickness
- Coil-coated Painted
- PVC Film Coated Galvanize Steel.
- 50 mm 14 kg/m³ Thickness Glasswool
- Box Profile And/Or Specially Formed Profiles
- Internal Wall Clad 8 mm. Thickness,
- Each Sides Are White-White Laminated Chipboard

Prefi
 PREFABRIK YAPI END. BİLİŞİM ve TİCARET LTD.ŞTİ.
 Ankara - İstanbul Karayolu, 30. km
 Akıncı Kavşağı, Kazan 06980 Ankara
 Tel:+90(312) 815 49 75(Pbx) Fax:+90(312) 815 49 78
 www.Prefi.com.tr e-posta: prefipref.com

ÇİZEN:
 DRAWN:
 KONTROL:
 CHK:
 ONAYLAMA:
 APPROVAL:

FİRMA /COMPANY:
CAMP FOR 50 PERSON
 TARİH/DATE:

BASLIK /TITLE: DINING HALL BUILDING (FOR 50 PERSON)	2 m
GLV-SLAM	82.77
REFERANS:	SAYFA /PAGE: 3/5

Prefi

6524

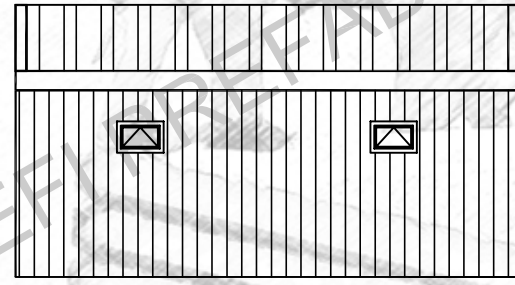
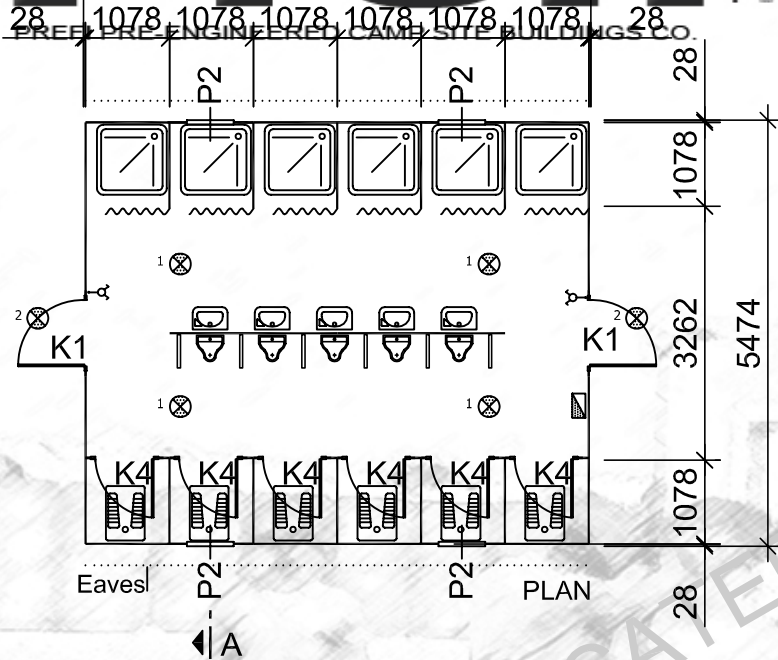

VIEW

0.50 mm. Trapezoidal Galvanized steel sheet
Steel Purlin
Rafter
50mm. 14 kg/m³ Glasswool Insulation
White Vinly Coated Gypsum Board

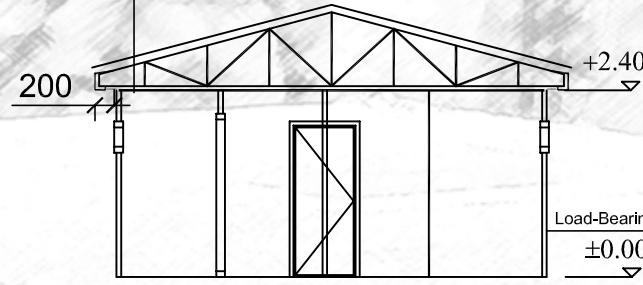

A-A SECTION

External Surfaces 0.70 mm Thickness
Coil-coated Painted
PVC Film Coated Galvanize Steel.
-50 mm 14 kg/m³ Thickness Glasswool
-Box Profile And/Or Specially Formed Profiles
Internal Wall Clad 8 mm. Thickness,
Each Sides Are White-White Laminated Chipboard

	SWITCH
	DOUBLE SWITCH
	1 X 40 TMS ARMATURE
	2 X 40 TMS ARMATURE
	LATERAL EARTH SOCKET
	TELEPHONE
	C TYPE GLOBE
	C TYPE GLOBE WITH WIRE GUARD
	4 x 18 PARABOLIC ARM
	(220V)SURFACE MOUNTING FUSE BOX
K1	850 x 2000
K2	840 x 2000
K3	1760 x 2000
K4	740 x 2000
P1	800 x 1100
P2	600 x 400
ALL MEASURED IN MILLIMETERS	

Prefi

PREFABRİK YAPI END. BİLİŞİM ve TİCARET LTD.ŞTİ.
Ankara - İstanbul Karayolu, 30. km
Akıncı Kavşağı, Kazan 06980 Ankara
Tel:+90(312) 815 49 75(Pbx) Fax:+90(312) 815 49 78
www.Prefi.com.tr e-posta: prefipref.com

ÇİZEN:
DRAWN:KONTROL:
CHK:ONAYLAMA:
APPROVAL:

FİRMA /COMPANY:

CAMP FOR 50 PERSON

TARİH/DATE:

BASLIK /TITLE:

TOILET&SHOWER BUILDING

2
m

GLV SLAM

35.71

REFERANS:

REV.NO:

SAYFA /PAGE:

4/5

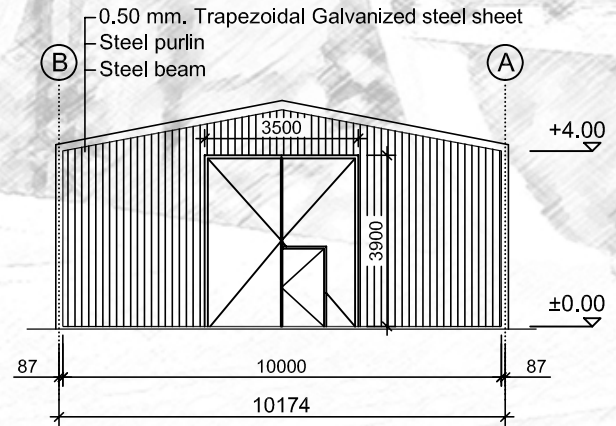
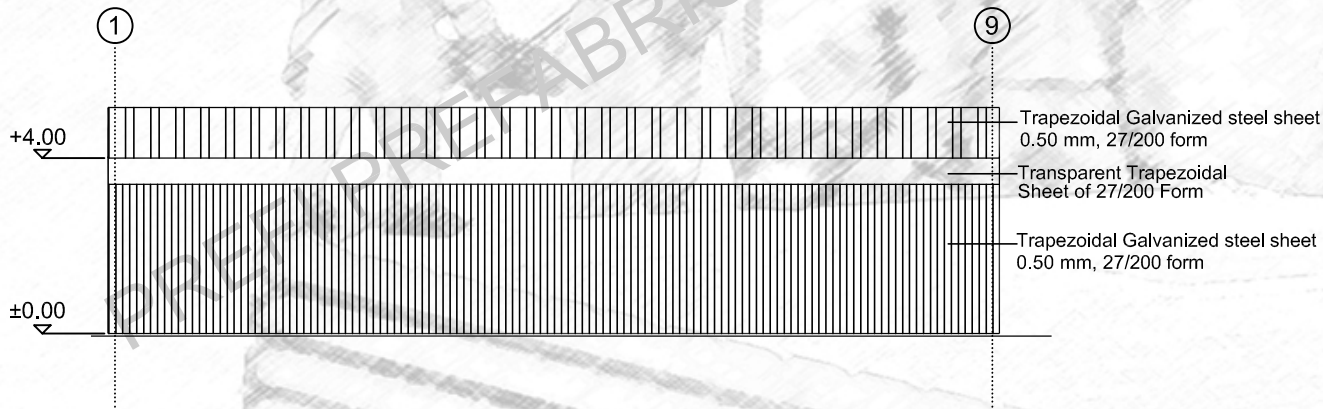
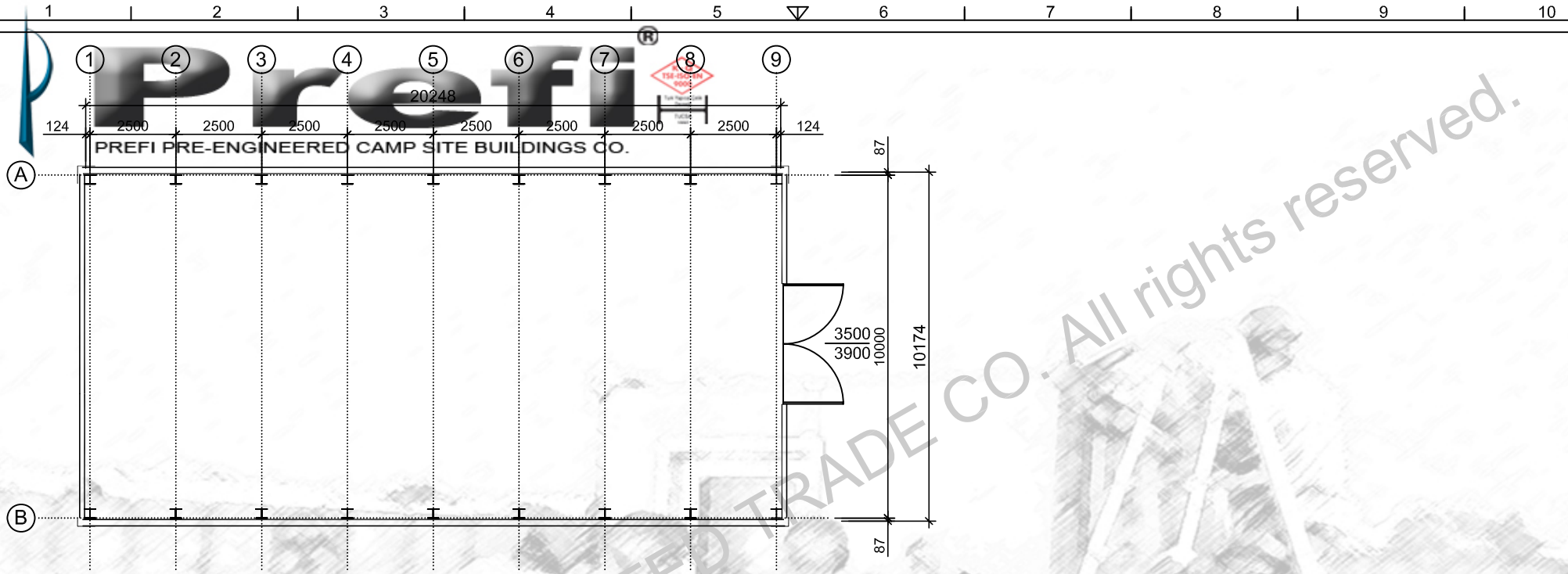

Prefi

PREFABRIK YAPI END. BİLİŞİM ve TİCARET LTD.ŞTİ.
Ankara - İstanbul Karayolu, 30. km
Akıncı Kavşağı, Kazan 06980 Ankara
Tel: +90(312) 815 49 75(Pbx) Fax: +90(312) 815 49 78
www.Prefi.com.tr e-posta: prefipref.com

ÇİZEN:
DRAWN:

KONTROL:
CHK:

ONAYLAMA:
APPROVAL:

FİRMA /COMPANY:

CAMP FOR 50 PERSON

TARİH/DATE:

BAŞLIK /TITLE:

WAREHOUSE

REFERANS:

REV.NO:

SAYFA /PAGE:

2
m

206.00

5/5



Prefi
PREFI PRE-ENGINEERED CAMP SITE BUILDINGS CO.

0.50 mm. Trapezoidal Galvanized steel sheet
Steel Purlin
Rafter
50mm. 14 kg/m³ Glasswool Insulation
White Vinyl Coated Gypsum Board

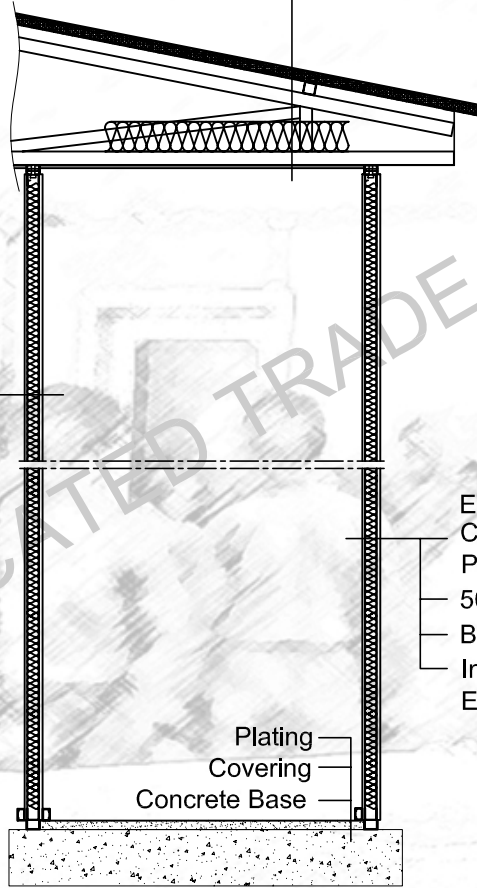

Internal Wall Clad 8 mm. Thickness Each Sides
Are White-White Laminated Chipboard
50 mm. 14 kg/m³ Thickness Glasswool
Box Profile And/Or Specially Formed Profiles
Internal Wall Clad 8 mm. Thickness Each Sides
Are White-White Laminated Chipboard

External Surfaces 0.70 mm Thickness
Coil-coated Painted
PVC Film Coated Galvanize Steel.
50 mm. 14 kg/m³ Thickness Glasswool
Box Profile And/Or Specially Formed Profiles
Internal Wall Clad 8 mm. Thickness
Each Sides Are White-White Laminated Chipboard

Plating
Covering
Concrete Base

Prefi

PREFABRIK YAPI END. BİLİŞİM ve TİCARET LTD.ŞTİ.
Ankara - İstanbul Karayolu, 30. km
Akıncı Kavşağı, Kazan 06980 Ankara
Tel: +90(312) 815 49 75(Pbx) Fax: +90(312) 815 49 78
www.Prefi.com.tr e-posta: prefipref.com

ÇİZEN:
DRAWN:

KONTROL:
CHK:

ONAYLAMA:
APPROVAL:

FİRMA /COMPANY:

TARİH/DATE:

BAŞLIK /TITLE:

PANEL DETAIL

GLV SLAM

2
m

REFERANS:

REV.NO:

SAYFA /PAGE:



A VIEW

Pre fi

PREFİ PREFABRİK YAPI END. BİLİŞİM ve TİCARET LTD.ŞTİ.
Ankara - İstanbul Karayolu, 30. km
Kazan 06980 Ankara/TURKEY
Tel:90(312) 815 49 75(Pbx) Fax:90(312) 815 49 78
www.Prefi.com.tr e-posta: prefi@prefi.com.tr

DRAWN:
CHK:
ONAYLAMA:
APPROVAL: **H. VAKUR YILMAZYİĞİT**

FİRMA /COMPANY:
TARİH/DATE:

BAŞLIK /TITLE:		DETAIL OF PANEL CONNECTION		2
		GLV-SLAM		m
REFERANS:	REV.NO:	SAYFA /PAGE:		